

Ammonia to Green Hydrogen Project

Feasibility Study



SIEMENS

ENGIE

 **Science & Technology
Facilities Council**

ecuity

AUTHORS

Ecuity

Clare Jackson

Kevin Fothergill

Peter Gray

Faisal Haroon

Engie

Camel Makhloufi

Nouaamane Kezibri

Andy Davey

Olivier LHote

Mures Zarea

STFC

Tristan Davenne

Simeon Greenwood

Adam Huddart

Josh Makepeace

Thomas Wood

Bill David

Siemens

Ian Wilkinson

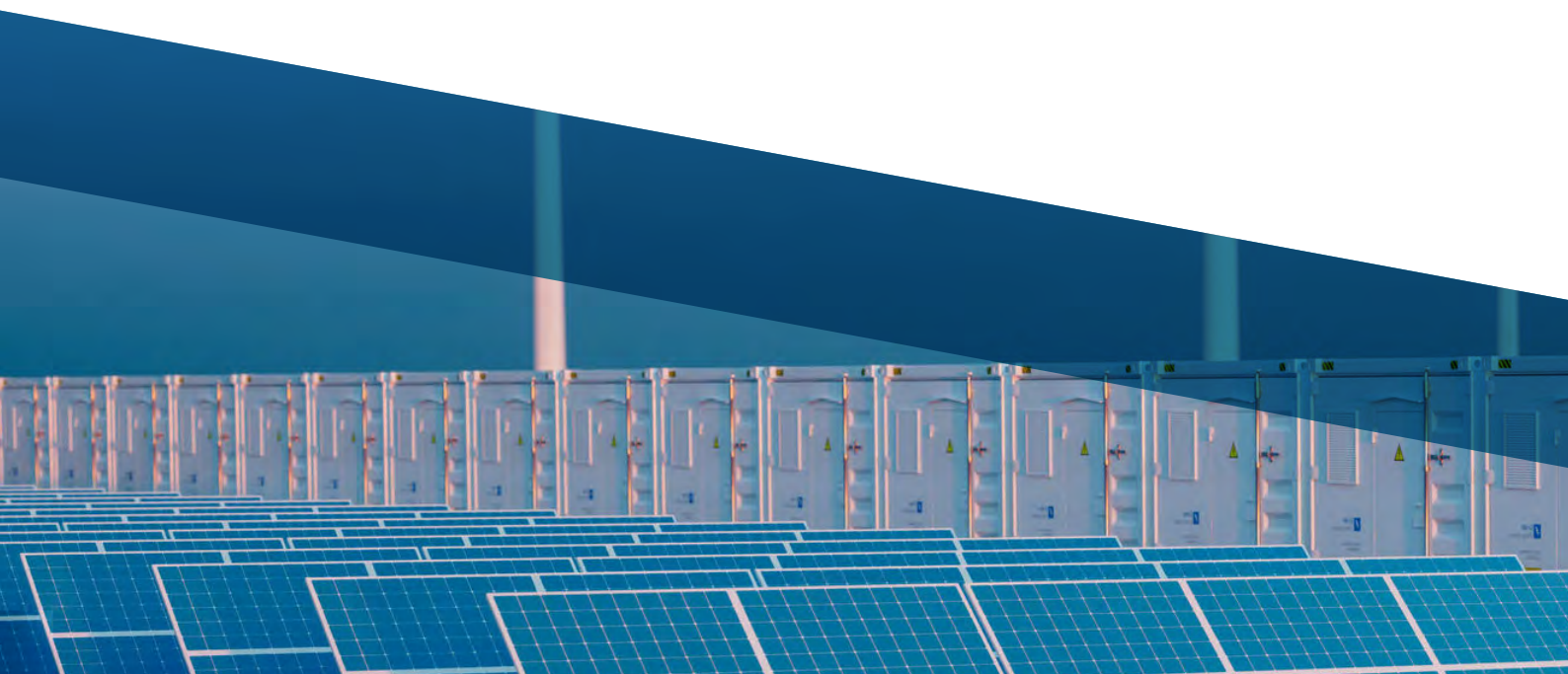

PAGE OF CONTENTS

AUTHORS	2
PAGE OF CONTENTS	3
1. EXECUTIVE SUMMARY	4
2. AMMONIA AS A HYDROGEN CARRIER	10
3. LARGE SCALE CRACKING MODELS	22
4. DEVELOPMENT OF A NEW LITHIUM IMIDE CATALYST	37
5. MARKET ASSESSMENT	54
REFERENCES	64
ADDITIONAL REFERENCES	69



1. EXECUTIVE SUMMARY

In a new energy paradigm where distributed renewable generation systems cohabit with increasingly larger wind or PV power plants located farther away from end users, the ability to effectively store large quantities of energy in a dispatchable form is a key element to ensure security and flexibility for the energy system. Energy storage provides a wide portfolio of services from grid services to the decarbonisation of energy intensive sectors including transport, industry, heating and cooling services. In this context, green hydrogen produced by electrolysis and blue hydrogen produced from natural gas with carbon capture and storage could be key to unlocking the full potential of renewables to decarbonise parts of the UK energy system and meet the net zero emission target. Despite this potential, the low volumetric density of hydrogen inhibits its use as an economically viable energy vector, even when compressed to high pressures or liquefied.

To overcome this disadvantage, a number of hydrogen 'carriers' have been considered. Amongst the available options, ammonia, in liquid form, is a carbon-free and readily dispatchable hydrogen carrier allowing the cost-effective storage and distribution of large quantities of renewable energy. The Committee on Climate change has noted that it "currently appears that converting hydrogen to ammonia as a means of transporting it over long distances would have lower costs than transporting it as hydrogen". The IEA suggests that for a number of regions, hydrogen imports in the form of ammonia could be cheaper than domestic production.

Ammonia has been produced in very large quantities for use as a fertiliser for over 75 years. It is a primary candidate to enable a secure supply of renewable hydrogen to the full range of stationary and mobile applications in the UK thanks to its existing infrastructures, ease of storage, well-defined regulation and very good safety history. Although ammonia production, handling practices and supply chains are mature and well established, efficient processes for the recovery of hydrogen from ammonia must be developed as efficient ammonia cracking technologies which can generate pure hydrogen remain in their infancy. This project aims to develop commercially viable cracking technologies and a commercial pathway allowing ammonia to enable the realisation of the hydrogen economy in the UK and beyond.

This project will demonstrate a new ammonia cracking technology with improved compactness, flexibility, efficiency, scalability and effectiveness in producing pure hydrogen compared to state of the art technologies. This will be achieved on a greater scale than has been achieved anywhere globally and will demonstrate how ammonia can act as profitable hydrogen carrier by enabling:

- The storage of large amounts of energy generated by renewable sources at times when supply exceeds demand.
- The transportation of hydrogen in the form of ammonia from distant generating sites to end users. This will enable cost effective distribution of renewable energy nationwide from very large-scale production units linked directly to large scale generation (e.g. offshore wind).
- The cost effective importation of renewable energy from regions of the world where renewable electricity generation is very low cost. This will open up international trade in renewable energy and provide the UK with previously inaccessible options for decarbonisation.



Specifically, the project has focussed in its first phase on two main areas:



Exploring the feasibility of centralised and decentralised cracking models and the design of a 200kg/day cracker that could meet the needs of the energy system



The development of a new catalyst technology that could significantly improve the efficiency and economics of cracking ammonia and the design of a 5kg/day cracker to test the performance of the catalyst in a demonstration pilot



The findings of the feasibility study are summarised below:

01 A decentralised model, whereby hydrogen is transported to the point of use and cracked onsite, using novel technology, is more economically favourable than a centralised model where imported ammonia is cracked centrally then transported as hydrogen to the point of use.

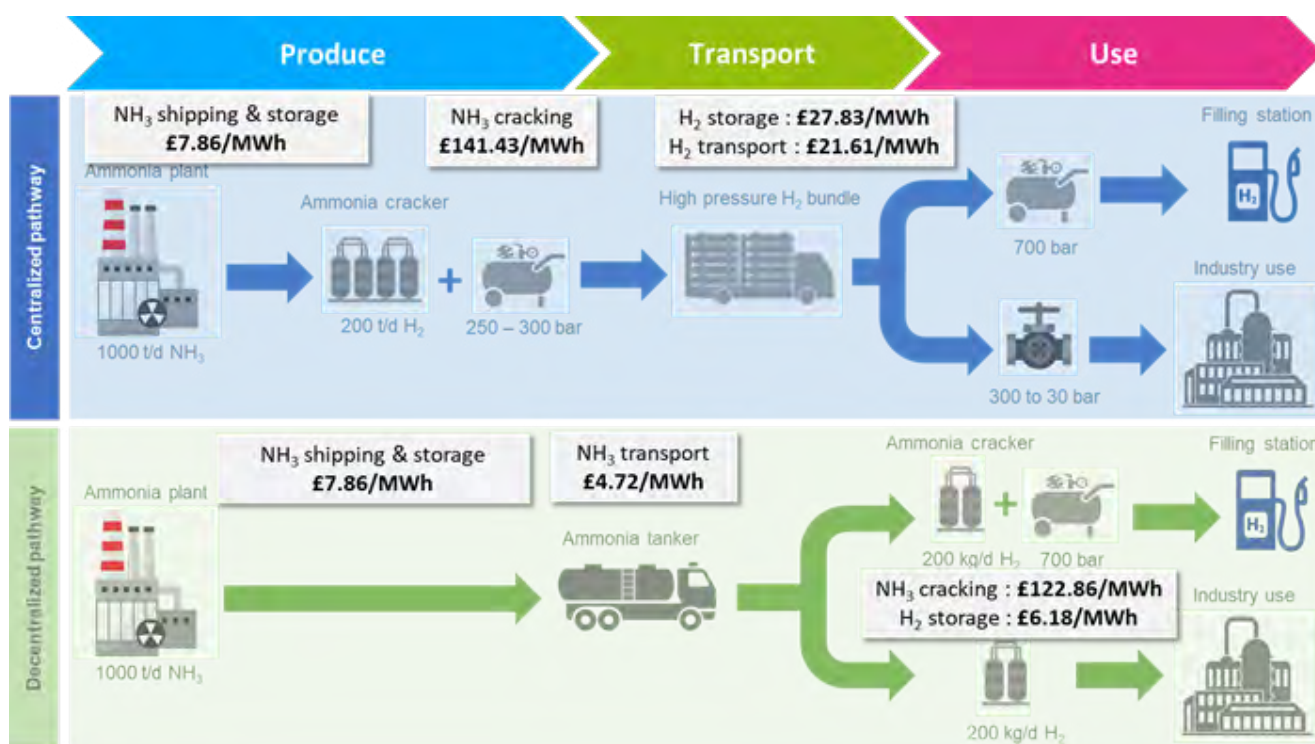

Centralised and decentralised models of ammonia decomposition

02 The case for a decentralised model becomes more compelling when hydrogen must be transported over greater distances. In both cases the use of ammonia as a hydrogen carrier can offer a competitive cost of delivered green hydrogen compared with other hydrogen transportation methods or onsite generation. The decentralised model is able to deliver green fuel cell grade hydrogen over a distance of 100km to the point of use at a total cost of £141.71/MWh (£4.72/kg H₂). These costs are based on current market rates for ammonia.

- 03** The purity of the hydrogen obtained through the modelling has been verified through small scale experimental development. The experimental rig yielded an H₂ purity of 99.9975% with NH₃ being below the detection limit of the FTIR (0.3 ppm). This will be verified in a full scale demonstration of the technology in a real world scenario.
- 04** The decentralised cracker designed through this project employs a novel use of integrated separation that gives the potential for an efficient commercial scale system. The costs and purity of the hydrogen generated through this cracker design open up immediate market opportunities such as enabling hydrogen production from offshore wind in the UK and the wider use of hydrogen within the transport sector.
- 05** The use of ammonia as a hydrogen storage mechanism is mature technology. Storage tanks for LPG which have a similar design and duty to tanks for ammonia have already been constructed up to 130,000 m³ capacity. A single tank of this size would hold approximately 0.5TWh of liquid ammonia. This storage solution is not geographically limited and could easily be scaled up in a modular fashion where needed. The immaturity of the ammonia decomposition technology is currently the only limiting factor.
- 06** Based on 2035 projected costs of renewable energy in different parts of the world, the low costs of solar energy projected in parts of the world such as the Middle East mean that the cost differential between producing green hydrogen in the UK through electrolysis and importing green hydrogen in the form of ammonia is significant. In the future it will be more cost effective to import green hydrogen in the form of ammonia and crack it in the UK than it will to produce green hydrogen in the UK. The end to end cost of importing hydrogen as ammonia from the Middle East would be £100/MWh compared to £120-150/MWh of UK based hydrogen generation.
- 07** The Lithium Imide Catalyst shows great potential to improve the economics of ammonia decomposition with lower costs and higher performance than the current state of the art catalysts used. The lithium amide-imide system showed significantly higher catalytic activity than sodium amide and ruthenium, reducing the temperature of 90% conversion by around 50°C.

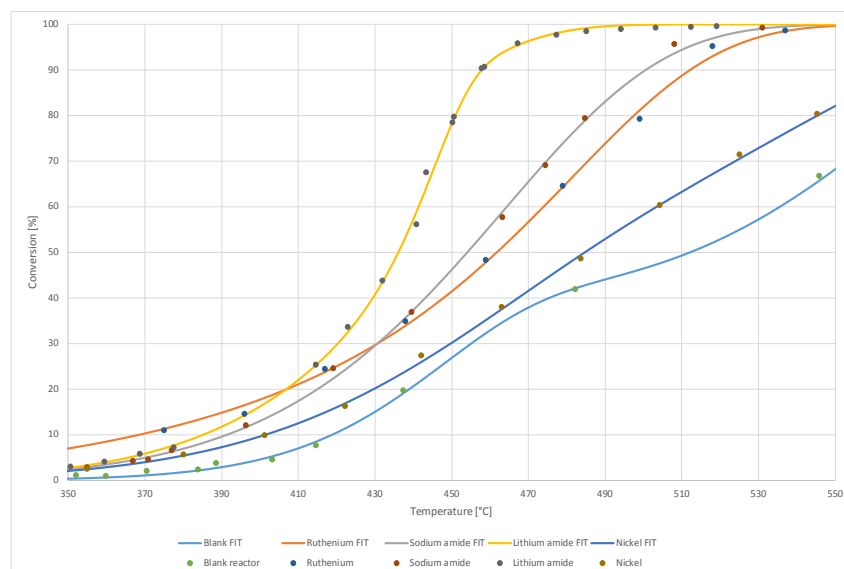

- 08** In addition to improving the economics of the ammonia decomposition process, the feedstock elements are far more abundant than current state of the art catalytic materials such as ruthenium. Together with the simpler catalyst formulation, the use of lithium imide is likely to result in cheaper catalyst formulations.
- 09** Through this project a small scale cracker has been designed with a novel integrated thermal management system designed for efficient and safe operation. The cracker would increase the TRL of the lithium imide catalyst but could also act as a future test bed for catalyst and separator development.
- 10** The consortium has designed two crackers for further development:
- A large scale, first of a kind, ammonia cracker capable of producing 200kg/day of hydrogen in a single step which will demonstrate the performance and economics of this solution.
 - A small scale ammonia cracker which will be used to improve the technology readiness level of the lithium imide catalyst, in order to discover the potential benefits of the catalyst and surrounding cracker design features at a commercial scale. Situating the cracker within the existing green ammonia site offers a unique potential to develop the complete ammonia energy pathway within a single facility.

Ammonia has a critical role to play in enabling the use of hydrogen to decarbonise the UK energy system. The development of the technology set out in this feasibility study will provide the missing link in an otherwise mature value chain and place UK companies and expertise at the forefront of an emerging global market.



2. AMMONIA AS A HYDROGEN CARRIER

According to the Committee on Climate Change, Hydrogen is a credible option to help decarbonise the UK energy system (15). Used selectively, alongside widespread electrification and improvements to energy efficiency, hydrogen has potentially valuable roles in replacing natural gas (e.g. for heating buildings on colder winter days, industrial process heat and back-up power generation) and liquid fuels (e.g. in heavy transport). Critically, the CCC stress that if hydrogen is to play a substantial long-term role, deployment of low-carbon hydrogen at scale must start now. Deployment of hydrogen should start in a 'low-regrets' way over the next decade, recognising that even an imperfect roll-out is likely to be better in the long term than a 'wait-and-see' approach that fails to develop the option properly.

Although zero-carbon hydrogen can be produced in several different ways (biological, nuclear), the predominant technology is/will be water electrolysis in which renewable electricity is passed through water, splitting it into hydrogen and oxygen. The hydrogen is captured and stored and subsequently used to regenerate electricity and/or heat without the emission of any CO₂.

Low-carbon hydrogen can be produced from fossil fuels using chemical processes such as steam reforming in combination with means of separating and capturing the by-product CO₂ for indefinite storage or for use in chemical manufacture (Carbon Capture and Storage or Use, CCUS). In this case, a significant proportion of the CO₂ (up to 90%) can be abated.

The locations where zero-carbon or low-carbon hydrogen can be most cost effectively produced are where there are consistent levels of wind or sun or where there is access to cheap natural gas. Such locations are often distant from end-user populations and consequently, it would be necessary to transport the hydrogen in large quantities, over long distances. Unfortunately, hydrogen has a low energy density by volume and the high cost of transportation rapidly offsets any cost benefits arising from its source. For hydrogen to become the "ideal" low or zero-carbon energy carrier, its shortcomings in storage and transportation need to be addressed.

2.1.1. Transport of Hydrogen in its native molecular form (gaseous phase or liquid phase)

Hydrogen is currently widely transported in both compressed gas and liquid forms. Supply chains across the world tend to differ based on the distances between production site and end-user, the scale of end-user demand and the weight restrictions on roads. For short distance deliveries (less than 60 miles, 100km) compressed hydrogen is transported in bundles of long cylindrical tubes, installed on trailers which will typically contain 250kg hydrogen per trailer. The amount of gaseous hydrogen that can be carried in tube trailers is limited by the weight of the steel tubes that contain the pressurised gas and gross vehicle weight limits. This is the most common method of hydrogen transportation in Europe.

Larger quantities of gaseous hydrogen can be transported by road in recently developed composite storage elements which can hold up to 1,100kg of hydrogen at a pressure of 500 bar (16) and composites technology is likely to enable trailers up to 700 bar in the future (17). Increased load carrying will extend the economic range of compressed hydrogen transportation.

Longer distance deliveries (200 – 300 miles) of hydrogen are typical in North America and liquid hydrogen is the more usual form of transport. Liquid hydrogen production in the U.S. is supported by the existence of several fully depreciated liquefaction plants which were developed for NASA programmes in the 1970s (18). Liquid hydrogen is transported by road in specially constructed and highly insulated cryogenic tanks containing typically 2,000kg, but up to 4,300kg. Boil-off losses and transfer losses are one of the challenges of handling liquid hydrogen. A recent US study estimates hydrogen loss of up to 25% in the whole service chain from production to dispensing to hydrogen fuelled vehicles (19).

Several options have been investigated to resolve the low energy density problem, including the transportation of hydrogen in liquid rather than gaseous form. Although liquid hydrogen has a significantly higher energy density than compressed gaseous hydrogen, it is still low compared to conventional fuels which are currently transported long distances (Figure 1). In addition, because of its very low boiling point (-253°C), between 30-40% of the energy content of the hydrogen is required to liquefy it (20) and further energy is required to maintain it in a liquid state during storage and transportation to minimise the aforementioned losses.



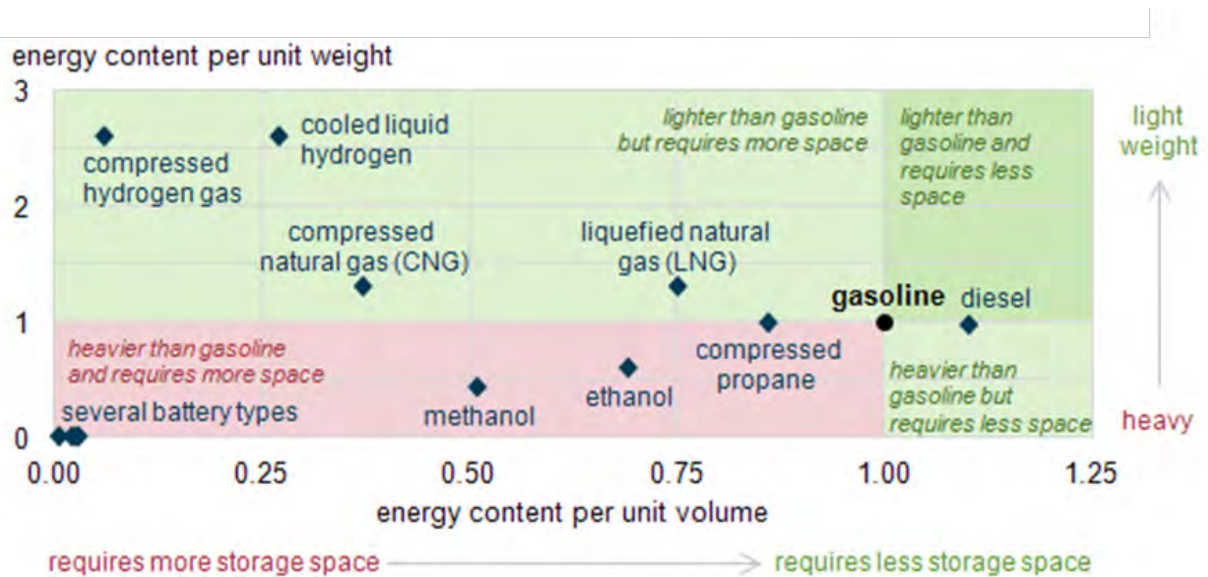

Figure 1: Energy density comparison of selected fuels (indexed to gasoline = 1) (21)

Many complexities are inherent in the production and storage of liquid hydrogen at -253°C (energy density of 9.98 MJ/l). Specifically, liquefaction of hydrogen requires the use of liquid nitrogen to pre-cool compressed hydrogen gas to -195°C , followed by hydrogen expansion to atmospheric pressure to liquefy and reach the -253°C liquid hydrogen temperature (22). This two-step process is required to pre-cool H_2 below inversion temperature of -71°C for it to cool upon expansion (22). For this reason, a more complex and costly cooling system using many compressors, pumps, heat exchangers, and a liquid nitrogen system is required for the liquefaction of hydrogen.

2.1.2. The need for an effective hydrogen carrier

Given the abovementioned limitations with storage and transport of hydrogen in its native molecular form (as either a gas or a liquid) other approaches have been taken to convert hydrogen into a form which has higher energy density and is relatively easy to store and transport. The primary candidates include LOHCs - liquid organic hydrogen carriers (including naturally occurring hydrocarbons), other organic molecules (e.g. methanol), metal alloy hydrides and liquid ammonia. Except for ammonia and metal alloy hydrides, all of these candidate compounds contain carbon.

In order for any type of hydrogen carrier molecule which also contains carbon atom(s) to have a zero or very low carbon footprint associated with its use the molecule must either be (i) directly recycled (i.e., via a dehydrogenation-hydrogenation recycle loop for synthetic LOHCs), or (ii) indirectly recycled in the case of hydrocarbons (i.e., the quantity of CO_2 released to the atmosphere when burning or reforming the hydrocarbon molecule must be no more than the equivalent quantity of CO_2 sequestered from the atmosphere when the hydrocarbon was first generated or synthesised – there must be no net release of CO_2).

The other category of directly recycled compounds, which in this case don't contain carbon, are the family of metal alloy hydrides. Here, hydrogen is generated by dehydrogenating the metal hydride (by heating and/or depressurising) and the depleted metal hydride must then be rehydrogenated to complete the recycling process. A useful amount of hydrogen is contained in metal hydrides and many types of metal alloy hydrides are available and some have been in use for many years for other applications (eg., NiMH rechargeable batteries). However, their use for very large-scale transport of hydrogen (eg., at the TWh scale) is infeasible due to (i) the substantial weight and volume of the metal alloy in comparison to the quantity of hydrogen it can transport (incurring a very significant transportation cost and carbon penalty), and (ii) thermodynamically, a large amount of heat must be provided to dehydrogenate the metal alloy hydride (to release the hydrogen) and equally, a large amount of cooling must be provided during the rehydrogenation process.

Directly recyclable LOHC compounds such as methylcyclohexane and dibenzyltoluene (and its hydrogenated derivatives) have useful hydrogen transportation properties, and as liquids they are less hazardous than gases, which can be inhaled. Methylcyclohexane is flammable and dangerous to ingest, and its production requires toluene (which is toxic). Dibenzyltoluene (which is currently used as a heat transfer fluid) is considered to be an alternative LOHC option and is safer. However, from an infrastructure perspective, neither are currently produced and handled in large quantities, except in specific chemical facilities, although safe handling in pipelines or ships is not thought to pose a significant safety problem with strict controls in place. Nevertheless, the same basic issues that render metal alloy hydrides infeasible for very large-scale transport of hydrogen (TWh scale) undermine the feasibility of using LOHCs for the same application: (i) transportation cost and carbon penalty incurred in physically transporting both the LOHC to its point of use, and then transport of the spent-dehydrogenated material back to a chemical plant for rehydrogenating, and (ii) the rehydrogenating and dehydrogenating process steps are non-trivial, requiring a significant amount of heat transfer (and elevated temperatures) and pressurisation, even with the aid of catalysts.

Indirectly recyclable hydrogen carrying molecules which also contain at least one carbon atom (eg., liquid hydrocarbons, LPG, LNG, CNG and alcohols such as methanol) rely on open-loop recycling of their carbon constituent in order to be correctly regarded as zero-carbon or low-carbon hydrogen carriers. In this case, the atmosphere acts as the conduit for cycling the CO₂ produced (by reforming or combustion of the hydrogen carrier) back to the "start" of the process in which that hydrogen carrier was first produced or generated. That is, the hydrogen carrier must have been produced renewably (free of any carbon footprint) in the first place for the hydrogen extracted from the carrier to be truly zero-carbon or very low-carbon (i.e., there must be no net CO₂ output in the overall cycle). Whilst there are a number of routes to produce the aforementioned hydrocarbon and alcohol molecules renewably (eg., biomethane, biomass gasification) they are severely limited by (i) the available amount of biologically sourced starting material (i.e., where biological processes have sequestered CO₂ from the atmosphere in the first place), and (ii) the overall efficiencies of these processes (starting from biomass) for producing the renewable hydrogen carrier are poor. Although it is technically feasible to non-biologically sequester CO₂ from the atmosphere (eg., using CO₂ adsorbents) and combine this CO₂ with renewable hydrogen (eg., from solar-PV driven water electrolysis), the overall efficiency of such a process is currently (and foreseeably) so poor as to render the concept infeasible.

2.1.3. Ammonia as a hydrogen carrier

In the above listing of hydrogen carrier candidates, ammonia is unique in that the non-hydrogen part of the ammonia molecule (i.e., the nitrogen) has no carbon and, very importantly, does not need to be directly recovered and recycled after the dehydrogenation step (to release hydrogen). The nitrogen originally comes from the atmosphere (of which it makes up 79%) and is returned to the atmosphere after the hydrogen has been extracted. So, providing the ammonia is generated renewably in the first place (from renewable hydrogen), there is no need for any of the above specified carrier “recycling” processes for ammonia to be a truly zero-carbon hydrogen carrier. Moreover, the process of production of ammonia with nitrogen taken from the atmosphere is highly efficient and far easier than taking carbon from the atmosphere by any route.

Liquid ammonia has several key merits, including its high hydrogen content (18% by mass), ease of liquefaction and similar physical properties to LPG providing an opportunity to use existing storage, transport and terminal equipment. Ammonia also has a long history of large-scale, cost optimised industrial production and its global use as a fertiliser, chemical raw material and refrigerant. As well, liquid ammonia is already transported over large distances with good economics.

2.1.4. Zero/low-carbon ammonia production routes

Ammonia production economics are dominated (70-90%) by the feedstock cost (23), so the potential for ammonia as an international low/zero-carbon hydrogen carrier is highly dependent on the economics of producing the necessary feedstock hydrogen in the locations where the low-cost low/zero-carbon hydrogen will be available and transporting it to the UK. Such locations include Australia, North Africa and the Middle East. In all three locations, there is potential for large-scale, low-cost generation of hydrogen from solar (together with wind) and, in the Middle East, there is also the potential for low-carbon hydrogen from natural gas and carbon capture and storage (CCS). CCS may also be potentially used at other sources of natural gas.

Figure 2 shows an evaluation by the International Energy Agency of hydrogen production costs, from natural gas, with and without carbon capture in various locations. The capital and operating costs of gas production and carbon capture are the same in each location, with the difference in total cost only determined by the relative price of gas. The lowest low-carbon cost is for the Middle East at just under £1.22/kg H₂ (£36.58/MWh H₂, LHV 33.33MJ/kg) very closely followed by the US.

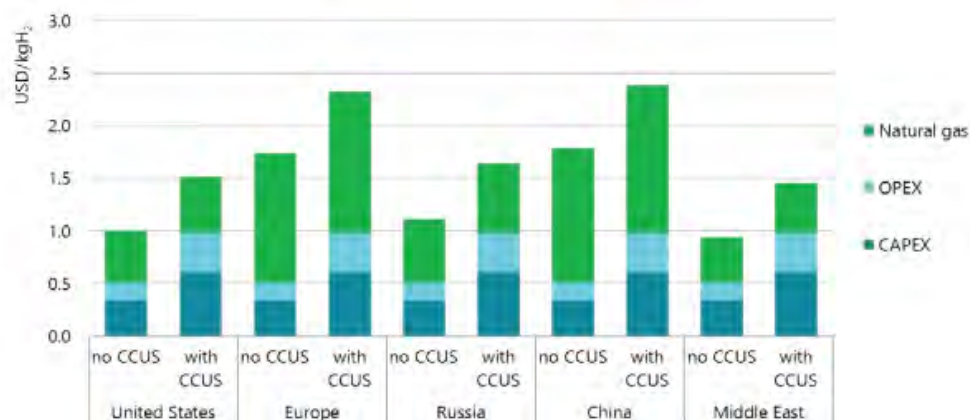

Figure 2: Hydrogen production costs from natural gas in different regions 2018 (24)

The low-carbon hydrogen cost in Europe is significantly higher at approximately £1.90/kg H₂ (£57/MWh H₂ LHV). In principle therefore, Middle East low-carbon hydrogen can be competitive in Europe if it can be converted to ammonia, shipped and reconverted to hydrogen of comparable purity for less than £0.69/kg H₂ (£20/MWh H₂ LHV).

The cost of zero-carbon hydrogen, produced from renewable electricity will depend upon the economics and scale of production, with the most significant factor being the cost of electricity. This is demonstrated in the chart on the right-hand side of Figure 3. Solar electricity generated in the Middle East is expected to be available at less than £24.40/MWh as indicated by bid process for several recent solar projects (25). According to IEA, this will result in a zero-carbon hydrogen cost of approximately £1.60/kg H₂ (£49/MWh H₂ LHV) at 4,000+ hours of load per year¹.

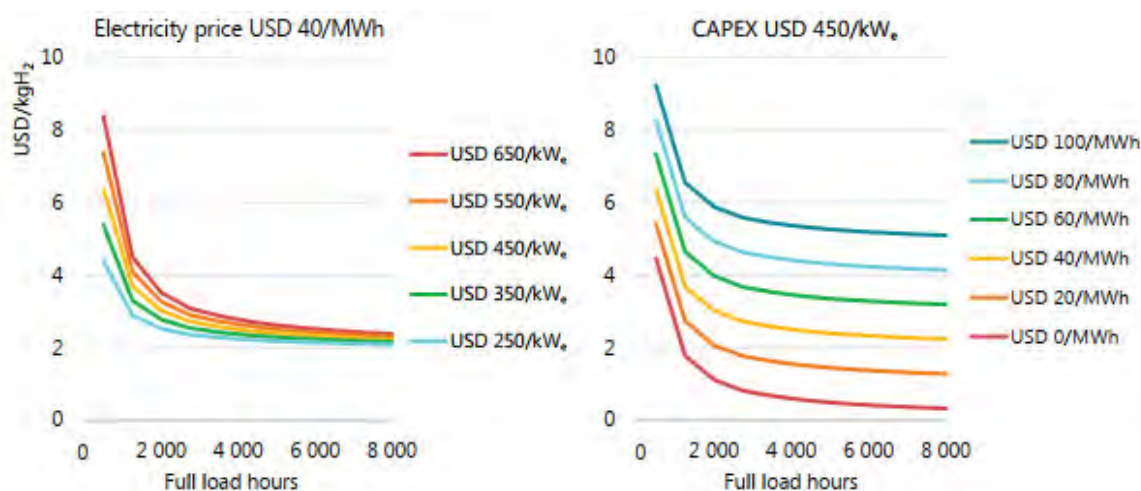

Figure 3: Future levelized cost of hydrogen production by operating hour for different electrolyser investment costs (left) and electricity costs (right) (24)² Note: Exchange rate of \$1.23/£ (27/8/19)

¹ It is expected that 4,000 fuel load hours would be achievable for solar in the Middle East.

² THE IEA has assumed an electrolyser efficiency of 69% (LHV) and a discount rate of 8%

For the UK, (26) produces an annual price projection for wholesale electricity. This suggests a long-term UK price of around £65/MWh which, per Figure 3 would correspond to a low/zero-carbon hydrogen production cost, by electrolysis, of £3.25-£3.66/kg (£98-£110/MWh H₂).

Irrespective of the source of the low/zero-carbon hydrogen (SMR/CCS or electrolysis) the process for manufacturing ammonia is the same and is very well established. Being invented in 1909 by Fritz Haber and Carl Bosch and first demonstrated at scale in 1914 (27). A typical modern ammonia plant is highly optimised and efficient and will produce in excess of 1,000 tonnes per day for use as fertilizer, as a raw material for various industrial products and as a refrigerant in large-scale industrial coolers. Because of the industry's maturity, the production, storage, transport and use of ammonia are well understood, cost optimised and low risk.

2.1.5. Ammonia production from natural gas (with CCS)

Where natural gas is used as the feedstock, it must first be converted into hydrogen, most widely using the steam methane reforming (SMR) process. This process involves the reaction of methane in the natural gas with steam to produce carbon dioxide and water. It is then necessary to remove the CO₂ from the product mixture to less than 500ppm before the hydrogen is used in the ammonia synthesis process. As a result, hydrogen production for ammonia already incorporates an effective method of carbon capture. Most ammonia plants use the captured CO₂ to produce urea (a product of reacting CO₂ and ammonia) which is sold as a solid fertiliser, although the CO₂ could be stored or used for other chemical processes.

Determining the ammonia production cost by SMR is not totally straightforward as the SMR-Haber-Bosch plant is usually not a stand-alone unit, but rather the front-end of an integrated fertilizer production complex. In this integrated configuration (which is typical of most plants worldwide), ammonia is an intermediate product (not the end product), which then flows on through the plant to make urea, ammonium nitrate etc. Only 11% of ammonia is traded (in the form of ammonia); i.e., 89% of the ammonia produced globally is as the intermediate chemical for direct production of fertilizers (urea, ammonium nitrate etc) in the same plant. However, some data is available in the public domain which allows estimation of the ammonia-only production cost: approximately 2/3 of the consumed natural gas is used as the chemical feedstock (source of H₂), while around 1/3 is required to provide the energy to drive the SMR process.

The geographical market price of the natural gas feedstock is the dominant cost driver for the ammonia industry as, except for very low-cost natural gas in the Middle East, it accounts for ~70-85% of the total ammonia production costs (Figure 4, (28)).

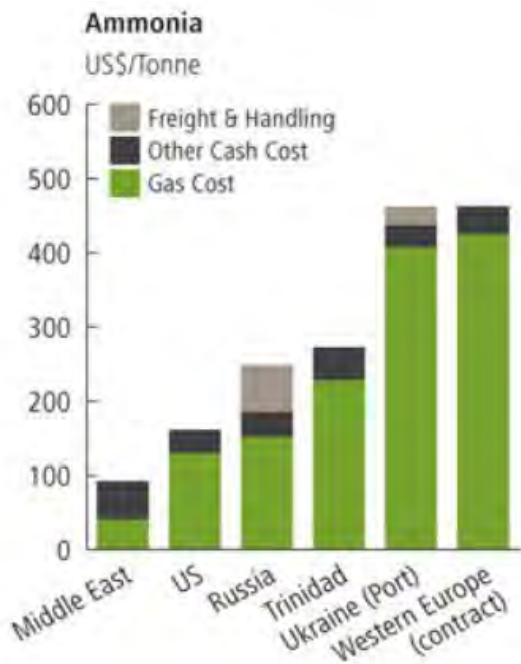

Figure 4: Ammonia production cost by Region. Source: (28).

Using data for the last ~ 5-year period (29), (30), it is possible to estimate the range of ammonia production costs in Western Europe by steam methane reforming, yielding a range of values from £0.16 – £0.31 per kg, giving an upper estimate of the cost of ammonia production in the world.

For the lower estimate of the cost range, Figure 4 indicates the USGC (US Gulf Coast) or the Middle East as the lowest cost producers. Since the data shown in Figure 26 is a bit dated, more recent USGC data (2018/19) has been used (31) (32); Henry Hub NG price). As the Middle East is no longer the biggest NG producer globally (overtaken by the US 1st and Russia 2nd) and F.O.B. Ammonia prices in the Middle East are now among the highest of the global producers who trade/export ammonia and most Middle East ammonia is exported as urea fertilizer, we have focussed here on fob USGC costs as being indicative of the current “lowest” ammonia production cost worldwide. This yields an estimate of ~ £0.11 per kg.

In summary, the estimated ammonia production cost range of £0.11 – £0.31 per kg worldwide over the last ~ 5 years is very large - whilst plant size/capacity/age (efficiency) and other fixed/capex/local costs are factors, the overwhelming cost driver is the natural gas cost, resulting in cost swings over time of as greater magnitude as volatile natural gas prices.

2.1.6. Ammonia production from renewable hydrogen

Hydrogen for ammonia production can also be produced renewably by electrolysis of water with the electricity supplied from wind or solar generation. The hydrogen produced from electrolysis is of high purity which enables simplification of the ammonia production process, avoiding the CO and CO₂ removal from hydrogen produced by the steam methane reforming processes.

Both wind and solar energy are well suited to hydrogen generation by electrolysis. Solar is particularly well suited as DC power transmission can be used, reducing the cost associated with the power electronics and AC-DC conversion. In locations with continuous, long and predictable sunshine, combined with hydrogen/energy storage and/or wind power (if wind resources are good) to cover periods of darkness, hydrogen and ammonia can be produced with very good economics. As described above, where solar or wind resources are optimal, the cost of electricity could be below £24/MWhe. At this price and with high load factors and a large plant, the cost of hydrogen would be less than £1.60/kg (32).

Storage and shipping of large quantities of liquid ammonia is much easier than storing and shipping hydrogen. Therefore, ammonia synthesis is best sited next to hydrogen generating plants. Such integrated ammonia production plants (currently with H₂ from SMR or electrolysis in the future) benefit from significant economies of scale, so tend to be very large (> 500,000t/y).

Figure 5 shows the costs of producing hydrogen for different electricity costs and load factors (expressed in full load hours per year), assuming a large-scale electrolyser cost of £365/kWe (NEL, 2017). The green line shows that in countries with very good combined solar and wind resources, renewable-energy based hydrogen generation (< £1.60/kg H₂) can compete with SMR. While similar H₂ prices could be reached in countries with lower-quality renewable resources if “surplus” electricity is considered free, it would not likely be available in sufficient quantity to run large-scale all-electric ammonia plants. Moreover, issues arising from the true intermittency of this surplus electricity supply from variable renewables would render this source unusable for an ammonia synthesis plant.

Based on extensive wind and solar geospatial data, Figure 6 shows large areas (from light green to yellow and orange) where a combination of 1-axis sun-tracking solar PV capacities and modern wind turbines combined would provide load factors over 50%, and up to 6000 FLH or more in the few red areas. The sum of the respective capacity factors of solar and wind has been corrected for overlap and surplus in this calculation made on an hourly basis, 365 days per year.

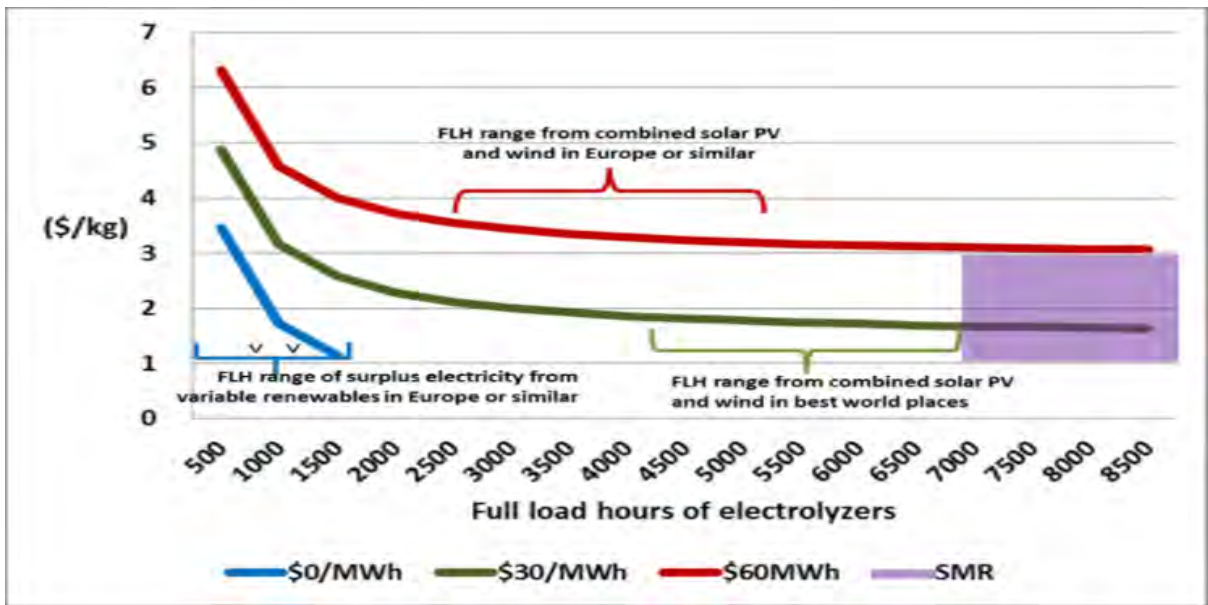

Figure 5: Cost of hydrogen from electrolyzers at USD 450/kW Capex for different electricity costs and load factors. (32)⁴ Note: Exchange rate = \$1.11/£ (27/8/19)

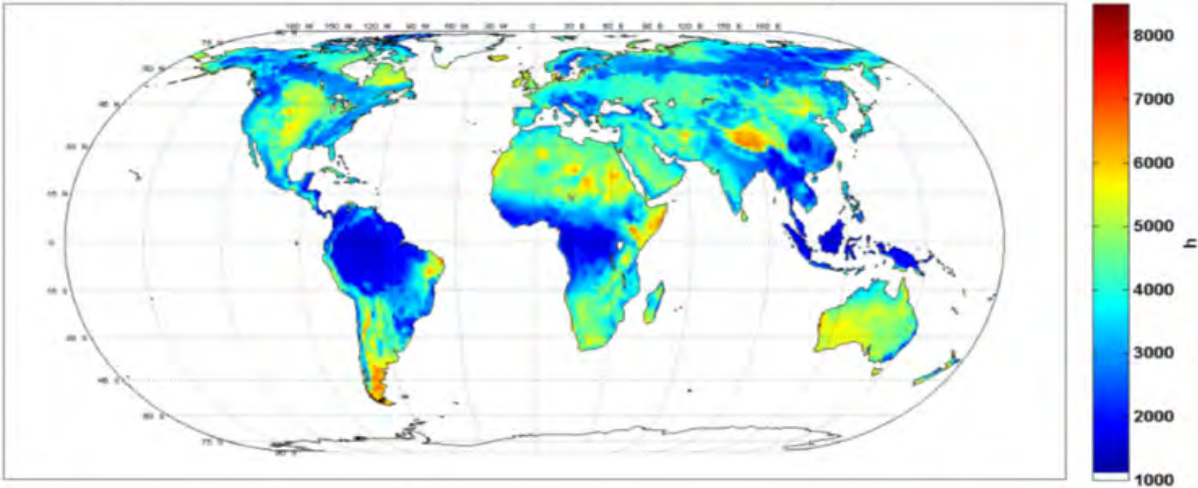

Figure 6: Hybrid solar and wind load factors adjusted for overlap. (32), adapted and based on Fasihi et al. 2016

⁴ Assumptions: Capex of electrolyzers \$ 450/kW (£365/kW) (NEL 2017), WACC 7%, lifetime 30 years, efficiency 70% (IEA 2015); cost of hydrogen from SMR \$1 to \$3/kg H₂ (£0.81-£2.44/kg), depending on natural gas prices.

Whilst there are many studies devoted to estimating the cost of H₂ (for transport and heat decarbonisation) produced via renewable electrolysis, there has been little work done on estimating the cost of renewably produced ammonia (via H₂ production by electrolysis) for use as a carbon free “carrier” for storage and for transport of large quantities of hydrogen over large distances. The few recent publications in this area have largely been concerned with the use of said “green ammonia” in sustainable production of basic chemicals and fertilizers. We have extracted pertinent raw data and insights from these publications to build a simple model to estimate the production costs of carbon-free ammonia, with the necessary hydrogen produced by water electrolysis powered by solar + wind (or solar + H₂/energy storage) operating at a minimum of at least 5,000 FLH.

In the 2012 report by the consultancy CE Delft “Identifying breakthrough technologies for the production of basic chemicals - A long term view on the sustainable production of ammonia, olefins and aromatics in the European region” a comparison analysis was made of the fuel/power consumption and CAPEX/OPEX for conventional and water-electrolysis based ammonia production for a 2,000 tpd ammonia plant. The electrolyser capital cost and the cost of electricity consumed by the electrolyser were by far the dominant cost drivers (with the underlying assumptions of a very large plant and long operating hours/high availability) in the analysis (done with electrolyser capex costs of £225/kWe & £450/kWe). We have re-evaluated these estimates using a range of input electricity costs, as shown in Table 1.

Table 1: Carbon free ammonia production cost (“CE Delft”) – effect of capex and electricity price.
Note €/\$ = 1.11 (27/8/19)

Low Capex assumption Cost				
Electricity price (£/MWh)	18	27	36	54
Specific production cost of Ammonia, £/kg	0.22	0.29	0.37	0.526
High Capex assumption				
Electricity price (£/MWh)	18	27	36	54
Specific production cost of Ammonia, £/kg	0.26	0.34	0.41	0.57

In order to narrow down this production cost range further, we removed the factors associated with the electrolyzers (capex and cost of electricity consumed by the electrolyzers) and replaced this with a specific hydrogen cost of £1.60/kg, taken from the previous detailed analysis. This gave the following results (with the low and high capex cases referring to all the plant, not including electrolyzers):

Table 2: Carbon free ammonia production cost (“IEA”) – effect of capex Note €/\$ = 1.11 (27/8/19)

Low (non-electrolyser) Capex assumption	
Electricity price (£/MWh)	27
Specific production cost of Ammonia, £/kg	429
High (non-electrolyser) Capex assumption	
Electricity price (€/MWh)	27
Specific production cost of Ammonia, £/kg	440

Whilst the above two analyses are effectively “theoretical”, insofar as there is no such (H₂ electrolyser + Haber-Bosch NH₃ process) large-scale plant existing today⁵, there is an analogue, very newly built, which comes closest to what such a carbon free ammonia production plant would look like. This analogue plant is the new Yara/BASF Freeport TX ammonia plant, opened 11th April 2018 (Ref: Yara Press release, 11 April 2018), at a total installed cost of over £488M and with a capacity of 750,000 tonnes/year. This plant is unique in that it has no hydrogen generation capacity of any kind - merchant N₂ and H₂ are supplied by local Praxair pipelines, with the hydrogen being a waste product from a nearby Dow Ethylene cracker. With this specific “real world” current capex cost of ~£0.73/kg NH₃ and a known established renewable electricity price of £24.40/MWh we can rework the estimates shown in Table 2, to give a single value for the estimate of the carbon free ammonia production cost of £0.44/kg. In this final analysis, the only key number which is still an assumption is the green hydrogen cost of £1.60/kg H₂ - insofar as this is a future estimate, not a real value which has actually been established today (the electricity price and the Yara/BASF capex are proven values today).

⁵ An ammonia plant with a production capacity of 50 tonnes ammonia per day and an electrolyser capacity of 15MWe is being built in Port Lincoln in South Australia, and will be powered by wind and solar electricity (47).

3. LARGE SCALE CRACKING MODELS

This section summarises the assessment of the role of ammonia as a hydrogen carrier at large scale, comparing two different approaches:

- 1 a centralized distribution strategy in which imported ammonia is reformed to produce hydrogen in large quantities; hydrogen being then dispatched to the point of use;
- 2 a decentralized strategy where ammonia is first transported to the point of use to recover hydrogen on-site using small cracking units.

A complete techno-economic evaluation has been completed to enable both strategies to be compared to each other and to assess which approach is most suitable in different scenarios

3.1. Large scale (200te/day) ammonia reforming unit

Today, there are no available or known processes to decompose ammonia at this scale. Most commercially available solutions offer an electric-based furnace solution at a production capacity ranging from 1 to 2 te/day. These commercial units usually produce a forming gas (H₂ and N₂ mixture) for various industrial applications and rarely include any additional steps to produce hydrogen at high purities. Our study designed and evaluated a large scale ammonia plant capable of producing fuel cell grade purity hydrogen at large quantities.

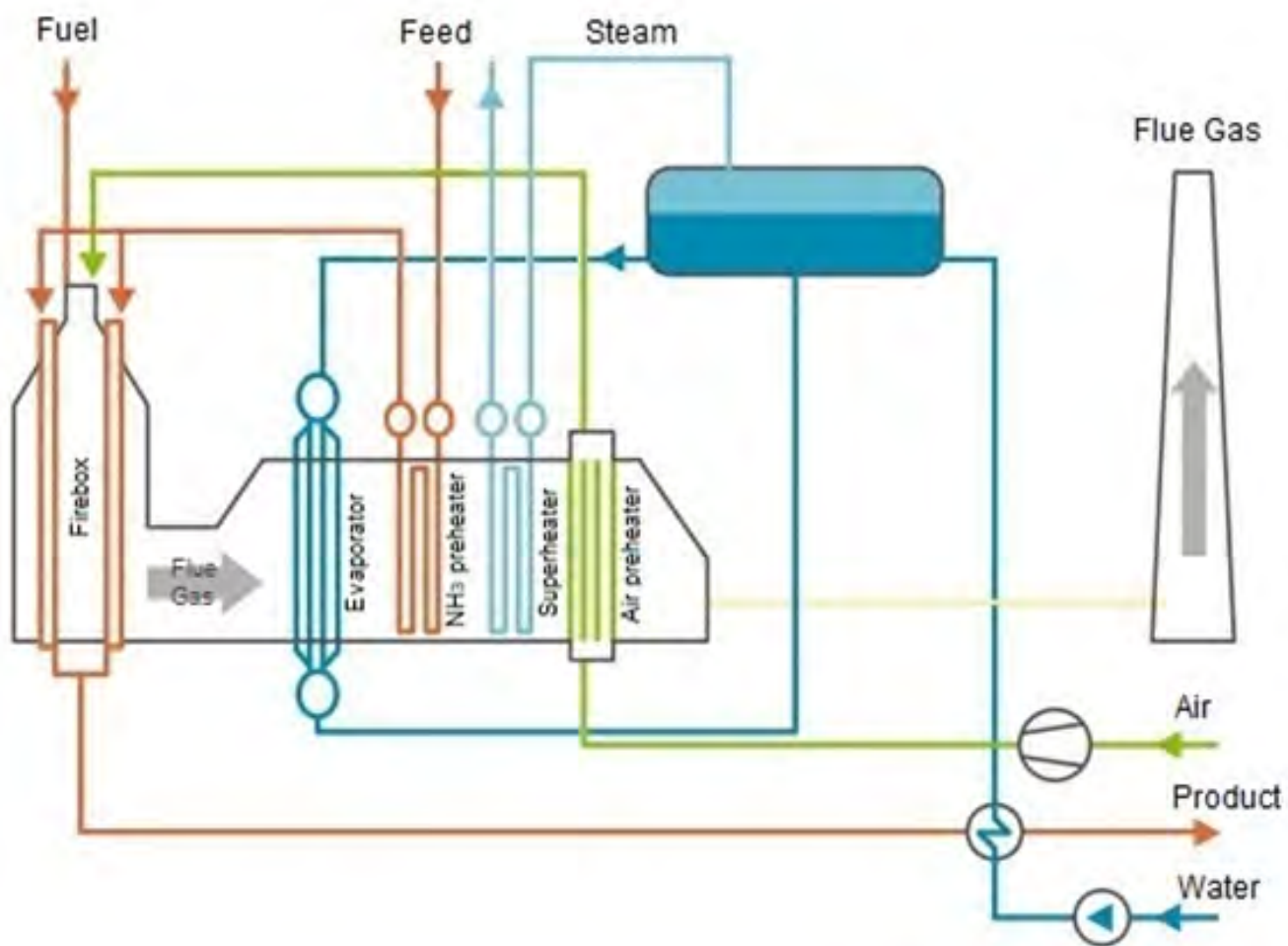

Figure 7: Final integrated design flowsheet



The detailed design of the ammonia reformer was achieved using simulation software of the Aspen Suite following a two-step iterative modelling approach. The conceptual design phase of this cracker revealed a trade-off between conversion rate and heat efficiency. Reaching high conversion rates leads to a suboptimal solution and in most cases an unfeasible one. Opting for an energy efficient solution leads to a smaller conversion rate due to heat transfer limitations.

Table 3: Flow streams data for fired reformer design shown in Figure 7

Stream	Composition	Conditions
Fuel	85% NH ₃ 15% H ₂	1 bar, 20°C
Feed	100% NH ₃	15 bar, 20°C
Steam	100% H ₂ O	40 bar, 345°C
Flue gas	67% N ₂ , 31% H ₂ O, <2% O ₂ /Ar	1 bar, 181°C
Product	69% H ₂ , 23% N ₂ , 8% NH ₃	2.3 bar, 380°C

To increase overall thermal efficiency of the established fired reformer design, a series of convection banks were used to recover heat from flue gas. Figure 7 displays a layout of the final design and Table 3 provides the composition and operating conditions of each stream. The convection section is subdivided into 4 compartments or banks with different functions each. The first one serves as a feed water evaporator, the second as a process ammonia evaporator, the third as a high pressure steam superheater and the last one as a combustion air preheater. This configuration allows recovery of most of the available heat in flue gas leaving the firebox. Thus, the overall thermal efficiency of this design reaches 93.1% at a 84.6% conversion rate of ammonia.

Overall heater duty is evaluated at around 119 MWth. Within this available heat input, only 45 MWth is used for ammonia cracking, 27 MWth for ammonia preheating and 38 MWth for superheated steam generation. Heat loss is assigned to the stack (5.8 MWth) and radiation loss in firebox (2.6 MWth). Cogenerated high pressure steam is used in a Rankin cycle to produce up to 15 MW of electricity.

The large-scale ammonia decomposition plant is designed to generate 200 te/day of high purity hydrogen, in bulk, using a step-by-step process as described in the bloc diagram provided in Figure 8.

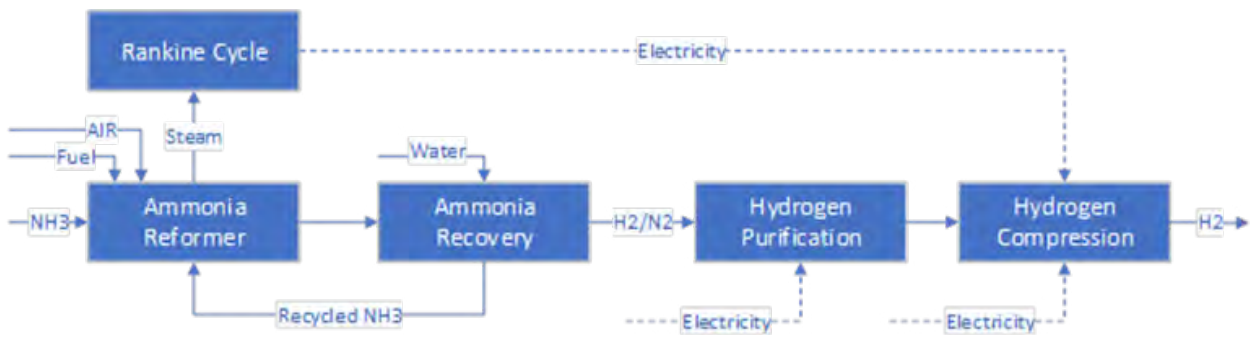

Figure 8: Block diagram of large scale ammonia cracking plant

The reformer outputs a forming gas composed of 69% H₂, 23% N₂ and 8% NH₃ and 18 kg/s of high pressure steam. The forming gas is fed to an ammonia recovery unit to recycle back uncracked ammonia to the reforming unit. The electricity produced from the high pressure steam is used to partly cover the gas compression work in the following steps. In order to eliminate nitrogen from the syngas, a purification section based on a liquefaction cycle is used to reach the target of 99.97% hydrogen purity. Finally, hydrogen is compressed to the delivery pressure.

To recover uncracked ammonia contained in forming gas mixture (around 8% in volume for the current design), an absorption/desorption process has been dimensioned according to flow rate, pressure and temperature levels of the process gas. In this process, water is used as absorbent exploiting the high solubility of ammonia in water. To regenerate the solvent, a stripping column is used to evaporate ammonia which is then cooled down and pressurized to be recycled back to the reforming step. With an 8 equilibrium stages absorption column, ammonia content in the syngas drops from 8% to 0.06%. The target is to reach fuel cell grade purity which is below 0.1 ppm. The following hydrogen purification step should meet this target. The stripping column has a 10 equilibrium stages and is able to recover up to 183 te/day of ammonia which is equivalent to 14% of necessary feedstock to operate at 200 te/day H₂ capacity.

The final step of the purification section is based on a cryogenic cycle. First, the forming gas with the remaining ammonia (600ppm) is compressed to 240 bar in a 6 stage compressor with intermediate cooling. Then, a series of 3 fin plate heat exchangers is used to bring down the temperature. The Joule-Thomson valve is used to expand the syngas to near atmospheric pressure. Heat integration is performed to recover most of the cooling needs from liquid nitrogen and low temperature hydrogen product. The cryogenic cycle cools the syngas to a temperature of -230°C which enables a nearly complete liquefaction of nitrogen. Thus, the hydrogen product reaches a purity of 99.97% which is suitable for fuel cell applications. With this current design, around 1.8 MW of external cooling power is required to operate the cryogenic cycle, this can be provided by an external refrigeration unit. The cycle could be improved through a better heat integration strategy with additional heat exchangers reducing the external cool needs.

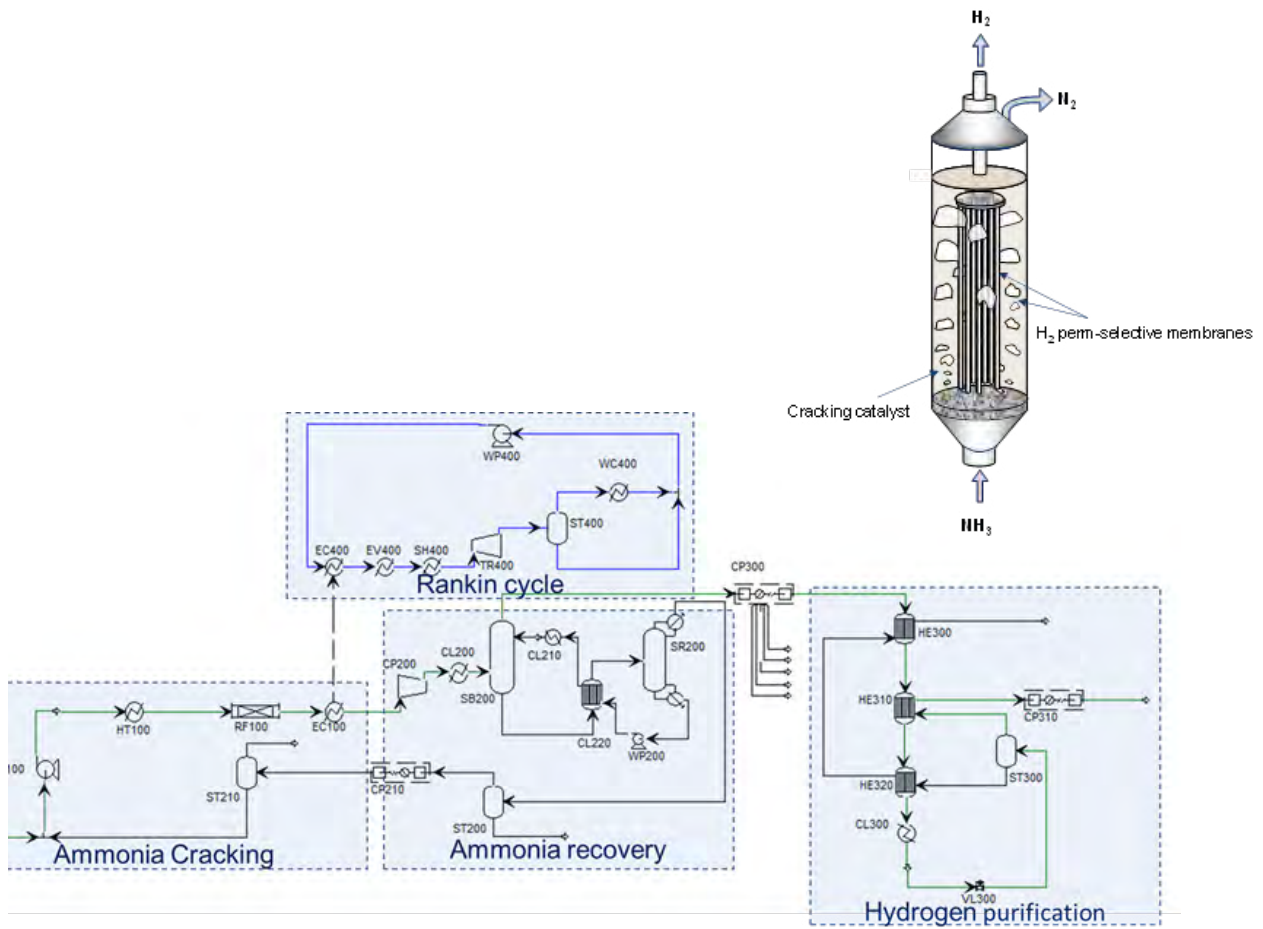

Figure 9: Complete model of the large scale ammonia cracking plant

The whole 200 te/day ammonia cracking plant was modelled using Aspen Plus™ tool to assess overall energy performance alongside with specific energy consumption (Figure 9). The obtained values of these two parameters are similar to typical values achieved with SMR technology. As shown in Figure 10, the large scale ammonia cracking plant is able to deliver high purity hydrogen at 250 bar with an overall efficiency of around 69% and a specific energy consumption of 12.65 MJ/Nm³.

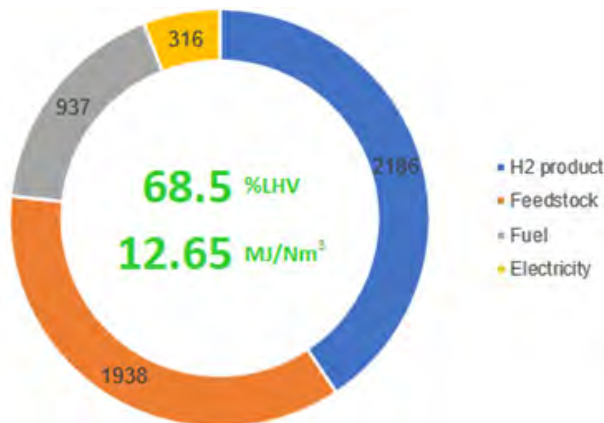

Figure 10: Energy distribution in GWh/year and performance of the large-scale ammonia cracking plant

3.2. Distributed ammonia reforming unit

3.2.1. Membrane reactor technology for ammonia decomposition

In a membrane reactor, the chemical reaction and the selective separation of a product of the reaction occur simultaneously inside the reactor. In chemical reactions limited by the thermodynamic equilibrium such as ammonia decomposition (other examples include steam methane reforming, water gas shift and propane dehydrogenation), the selective separation of one of the products (H_2 in this case) will shift the thermodynamic equilibrium according to Le Chatelier's principle, thus allowing the system to go beyond this thermodynamic constrain. This brings several advantages over conventional systems:

- Pure H_2 is recovered through the membranes, which can be fed directly in fuel cells, and avoids any costly downstream separation unit.
- The thermodynamic equilibrium limitation is circumvented, and it is possible to obtain full fuel conversion, reducing the downstream cleaning of unconverted species.
- The separation of H_2 allows to get higher efficiencies at lower operating temperatures. This has a corresponding benefit from an energetic point of view.
- Since the whole process occurs in a single unit, the footprint of the technology is reduced.

For selective H_2 separation, typically Pd-based membranes, which show a unique transport mechanism for H_2 permeation, are used. The use of a membrane reactor for ammonia decomposition has recently been presented in the literature and some of these advantages have been experimentally demonstrated at lab scale [1,2]. However, the reactors used were very small, using tantalum tubes as membrane support, which show a selective diffusion for H_2 , but are prohibitively expensive for this application.

In our work, a membrane reactor up to 40 times larger than those presented in the literature has been constructed, and the ammonia cracking in the membrane reactor has been demonstrated under different operating conditions. Additionally, a reactor model able to predict the behaviour at the different conditions has been developed, and subsequently used for the design of a distributed unit of 200 kg/day of H_2 . For the experimental validation and further scale up, a commercial catalyst was selected, and the membranes used based on patented double-skin Pd membranes, which have shown outstanding performances for H_2 separation with improved stabilities.

3.2.2. Lab-scale demonstration

This section summaries the experimental proof of concept of the ammonia cracking technology including the description of the experimental setup constructed for this purpose, a detailed description of the H_2 -selective membrane used, and the main experimental results obtained from this work.

3.2.2.1. Pd-based Membranes

A Pd-Ag layer has been deposited onto a porous tubular as shown in Figure 11, where the total active length of the membrane is 202 mm.



Figure 11: Left: picture of the membrane before integration into the membrane reactor. Right: picture of the membrane used in this work.

The N_2 permeance has been measured along the testing period, giving a stable value of $3 \cdot 10^{-12}$ mol/s/m²/Pa. This very low value of N_2 permeance results in an extremely high ideal H_2/N_2 perm-selectivity ($> 600,000$), one of the highest found in the literature considering the high H_2 permeance (> 1.5 mol/s/m²/Pa) at a maximum temperature of 450°C. This membrane is considered as the standard product that can be fabricated for the project.

3.2.3. Experimental setup

For the experimental demonstration, a commercial Ru-based catalyst (2% wt.) supported on alumina pellets was used. In total, 250 grams of this catalyst were introduced in the tubular membrane reactor until the membrane was fully immersed in the packed bed catalyst. The reactor is made of SS 310L with an inner diameter of 4.5 cm and an active length of 25 cm.

The reactor was placed inside an electrical split-oven with three heating sections, to ensure an even temperature distribution along the reactor. The outputs from the gas cylinders are fed into the system through mass flow controllers. For the proof of concept, up to 0.5 LN/min of pure ammonia have been fed into the reactor. From the reactor retentate (mostly N₂ and non-recovered H₂) the gases pass first through a gas filter (7 µm mesh size), which protects the downstream equipment. Subsequently, this gas is sent to the analytical section, where the ammonia conversion is calculated by means of gas chromatography. From the permeate side (the ultra-pure H₂ stream), the gas is sent to an FTIR (from Shimadzu) mounting a 10 meter gas cell (from Specac) and an MCT detector, where the impurities of the membrane can be measured. The two gas lines are subsequently mixed and sent to a water absorption unit where unconverted NH₃ is absorbed. All the lines from the permeate until the analytical section are made of SilcoNert and PETF in order to avoid any adsorption of the NH₃ in the gas lines that can influence the FTIR readings. A picture of the experimental setup can be found in Figure 12, with the membrane reactor, feeding system and absorption module to the left (area 1), the the analytical equipment to the right (area 2) with a safety section inbetween (area 3).

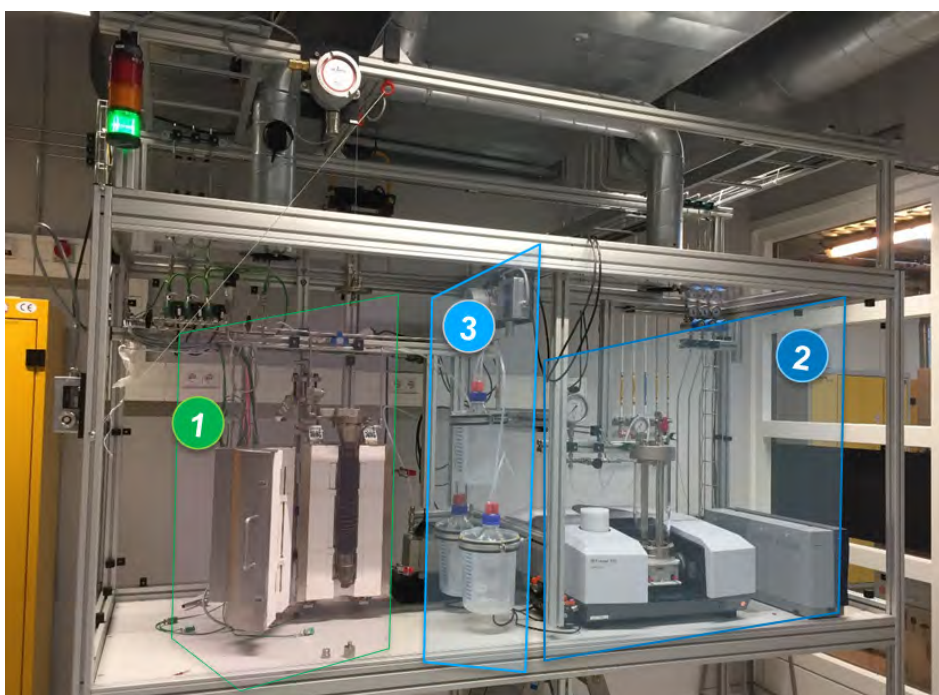

Figure 12: Experimental setup used in this work. (1) reaction section, (2) analysis section – FTIR and GC, (3) safety section – sensors and gas scrubbing

Prior to starting the experiments, the reactor is heated at a rate of 2°C/min in N₂ atmosphere to reach reaction temperature. Pure NH₃ is fed into the reactor and the reaction is kept for 3 hours until steady state operation is observed, with NH₃ conversion continuously monitored. The operating temperature of the ammonia decomposition has been varied between 400 and 450°C, with experiments conducted at different feed pressures and permeate pressures. A vacuum pump installed in the permeate line (MP301Z-X2 from Acclon technologies), allowed the influence of the permeate pressure on the performance of the technology to be evaluated.

The results summarised here are given as ammonia conversion and H₂ recovery as presented in Eq 1 and Eq 2. The H₂ recovery refers to the total amount of pure H₂ separated through the membranes compared to the total amount of H₂ fed in the reactor in the form of ammonia.

$$\text{Ammonia conversion: } X_{\text{NH}_3} = \frac{\text{NH}_{3,\text{in}} - \text{NH}_{3,\text{out}}}{\text{NH}_{3,\text{in}}} \quad \text{Eq 1}$$

$$\text{H}_2 \text{ recovery factor: } \text{HRF} = \frac{H_{2,\text{permeated}}}{3/2 \text{NH}_{3,\text{in}}} \quad \text{Eq 2}$$

The stability of the membrane reactor is demonstrated by the results from continuous operation during 3 hours for experiments carried out at different temperatures (400, 425 and 450 °C and at 5 bar(a) feed pressure, keeping the permeate at atmospheric pressure). Figure 13 shows ammonia conversion over time is very stable.

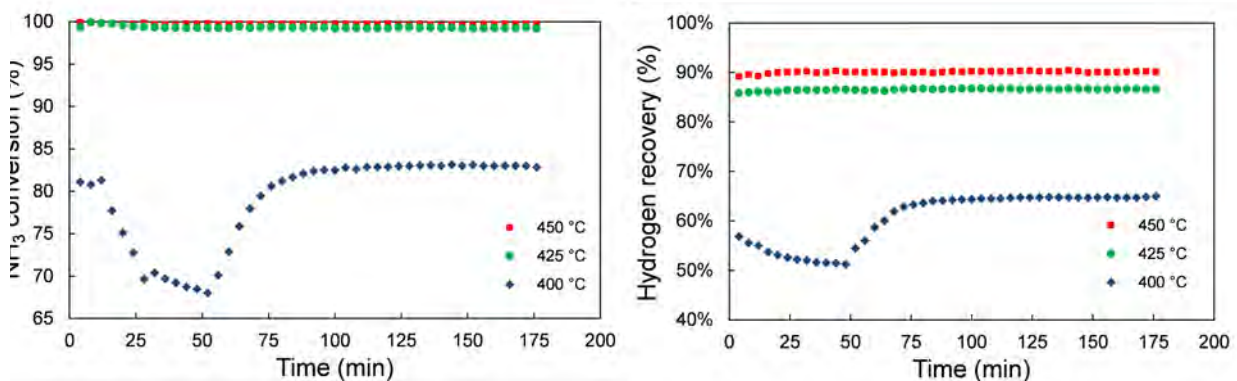

Figure 13: Ammonia conversion (left) and H₂ recovery (right) at different temperatures for a feed pressure of 5 bar(a) and a permeate pressure of 1 bar.

From these results, it can be observed that the kinetics have increased, resulting in higher ammonia conversions which, in its turn, lead to higher H₂ partial pressures inside the reactor. Since there is now a higher driving force, more H₂ can be extracted through the membranes, resulting in an increase in the kinetics and virtual full ammonia conversion (99.2 and 99.7% at 425 and 450 °C respectively). This ammonia conversion is higher than the equilibrium conversion at such operating conditions. Furthermore, at these temperatures and operating pressures, more than 86% of the H₂ content in the ammonia has been recovered in-situ from the membrane reactor.

During all experiments, the purity of H_2 has been determined, and a minimum value of 99.9975% has been obtained with NH_3 being below the detection limit of the FTIR (0.3 ppm). The H_2 quality obtained in this work is thus adequate for its use in fuel cells.

Simultaneously, a membrane reactor model has been developed and validated in this work. This is a 1D reactor model solving the mass balance in small discretization grids. The kinetics have been taken from the literature for the catalysts used in ammonia decomposition and the H_2 permeation expression is described by Fick's law with the permeability, activation energy and pressure exponent the ones calculated experimentally before starting with the experiments.

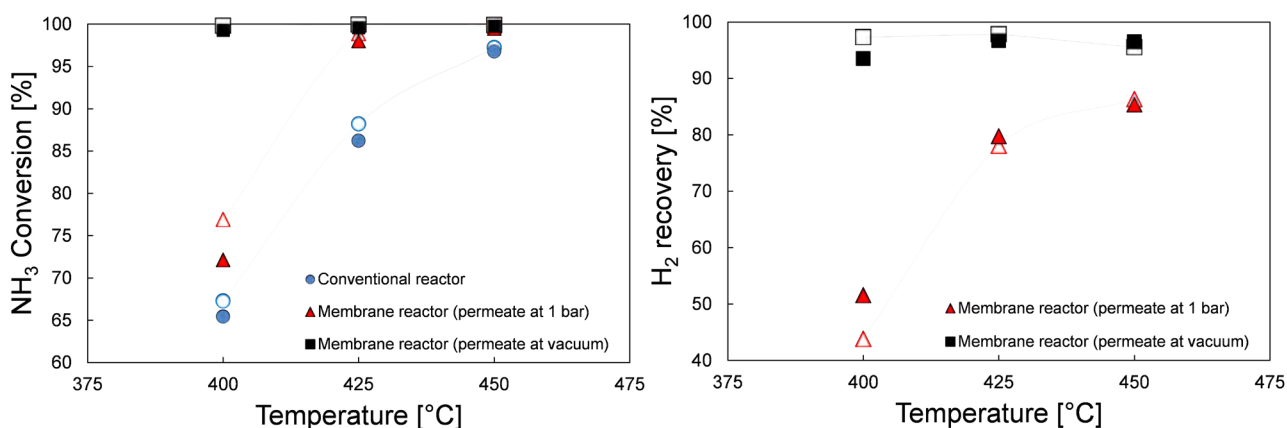

Figure 14: Comparison between experimental data (filled markers) and modelling data (open markers) in terms of NH_3 conversion (left) and H_2 recovery factor (right) at different operating conditions and reactor configurations.

In Figure 14, the experimental results presented in Figure 13 are plotted against the modelling results (empty markers) predicted for the different operating conditions used in this membrane reactor. This shows good correlation between modelled and experimental results and hence we can conclude the reactor model is able to predict with relatively good accuracy the experimental values obtained during the proof of concept of the ammonia decomposition reaction in the membrane reactor technology. The largest deviations occur at the lower temperatures where in this case the kinetics of the real catalyst used were not measured, but data from the literature is used.

Based on these results, the technology for distributed applications has been designed, with a selected temperature of reaction of 450 °C, where the model can predict accurately the reactor performance, both in a conventional cracking technology, or in a membrane reactor. Under these assumptions, the complete process has been built in Aspen Plus™. In this case, the heat integration is of high importance, as it strongly influences the overall efficiency of the process. To minimise carbon footprint, part of the H_2 permeated can be combusted and supply the energy required for the process. Through this design, we achieve an overall process efficiency of 89% (based on LHV) and 77.6% H_2 recovery rate.

3.3. Techno-economic assessment of ammonia cracking pathways

3.3.1. Total capital investment

- **Total Capital Investment (TCI) is the aggregate of:**
 - Purchased equipment costs - all costs required to purchase equipment needed for the control system (see Figure 15),
 - Direct installation costs: the costs of labour and materials for installing that equipment,
 - Indirect installation costs: costs for site preparation and buildings, and certain other costs,
 - Costs for land, working capital, and off-site facilities.

For both pathways, purchased equipment costs were estimated based on general plant layout and process requirements. The purchased equipment costs for the centralised unit amount to £74.85m while they amount to £282k for the decentralised unit. Figure 15 displays equipment cost breakdown for each case.

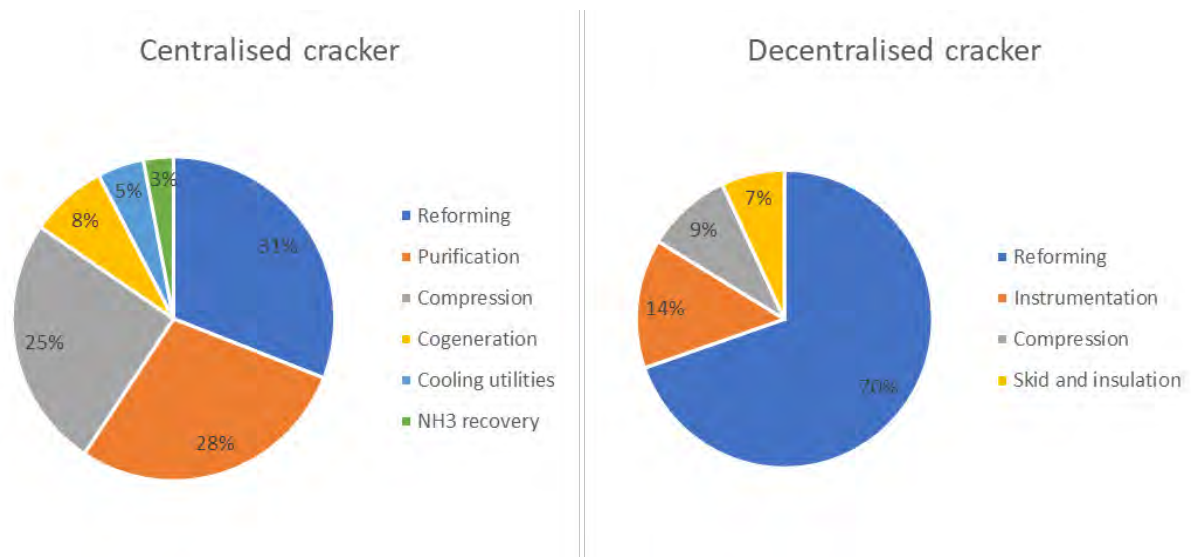

Figure 15: Purchased equipment cost breakdown for the both ammonia cracking units

In the centralised unit case, TCI is directly correlated to the key purchased equipment cost including all the components that were designed and dimensioned in the conceptual design step.

For the decentralised cracker, a complete cost analysis has been carried out based on the conceptual design of the decentralised 200 kg/day cracker. First, a membrane reactor has been designed, where the volume of reactor, catalyst and membrane area have been evaluated. Subsequently, the costs of all the BoP components have been assessed. In this analysis, all the equipment costs are based on real purchases of a similar membrane reactor unit, where the target was to produce 20 Nm³/h of H₂ from natural gas. This minimises the error margin in our cost estimates and provides us confidence that actual costs will be within ±5%.

With these purchased equipment costs estimations, the TCI of the centralised 200 te/day unit and the 200 kg/day system are assessed:

- The capital cost of the centralised unit is expected to reach £368m of which 61% is direct costs and 24% is indirect costs. TCI costs represent here a contribution of 1323 £/kW.
- The capital cost of the decentralised ammonia cracking is estimated at £482k including 76% of direct costs and 24% to indirect costs. Total capital investment costs represent here a contribution of 1733 £/kW.

This highlights the importance of scale on economics of ammonia cracking since larger capacities have a lower CAPEX requirement (per kW)

2.3.2. Overall cost of hydrogen production

The overall cost of hydrogen is a critical parameter to assess the economic viability of the whole plant. Following the expression in Eq 3, the overall cost of hydrogen production is a combination of three main factors namely capital investment (which was assessed earlier), fixed operational costs and variable operational costs⁶.

$$COH = \frac{(TCI * CCF) + C_{O\&M,fix} + (C_{O\&M,var} \times 90\%)}{Capacity \times 8760 \times 90\%} \quad \text{Eq 3}$$

The overall cost of hydrogen for the designed 200 te/day plant has been estimated to range from £4.72/kg to £5.19/kg (or from £141.4/MWh to £155.3/MWh on LHV basis), with the cost of ammonia having the highest influence on the overall cost of hydrogen. For a 10% raise in green ammonia price, the overall cost of hydrogen increases by around 5.4%. Other variable costs such as electricity and reforming catalysts have a lesser impact on the overall cost of hydrogen as illustrated in Figure 16.

⁶ CCF : capital charge factor; CO&M,fix fixed annual costs ; CO&M,var : variable operation costs

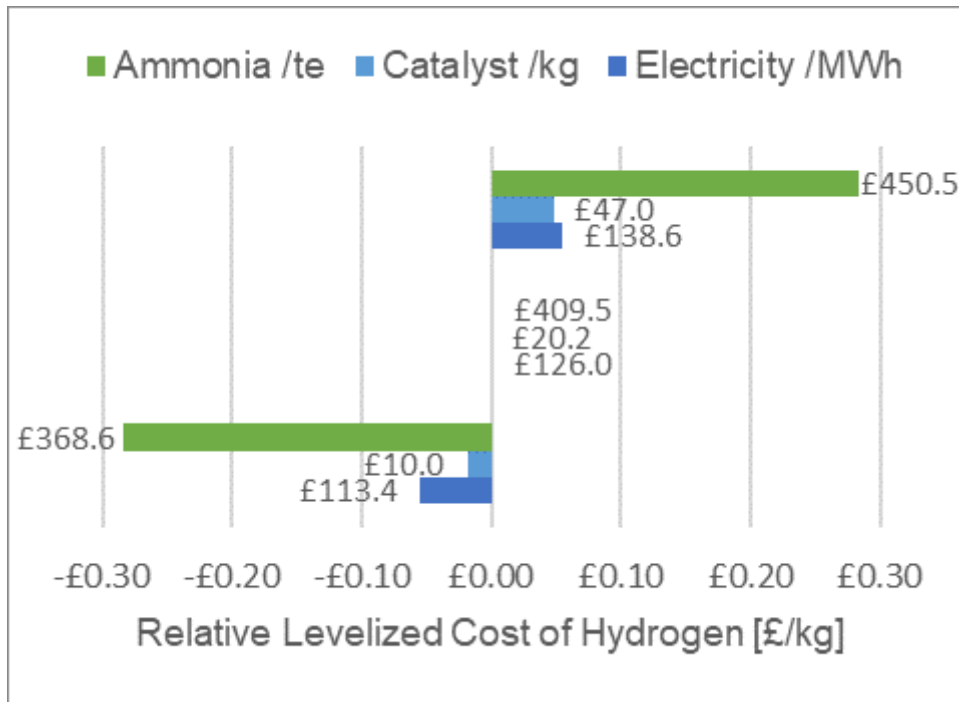

Figure 16: Impact of main O&M variable costs on COH of the centralised unit

For the decentralised unit, the Cost of Hydrogen is £4.65/kg (or £139.5/MWh), with potential to achieve £4.09/kg (or £122.86/MWh) through further cost reductions (from further improvements at reactor and system levels, and more optimistic maintenance cost assumptions), see Figure 17. Our analysis shows that whilst membrane reactor represents the main cost in terms of equipment, the COH is dominated by OPEX (77%, of which 86% are variable costs).

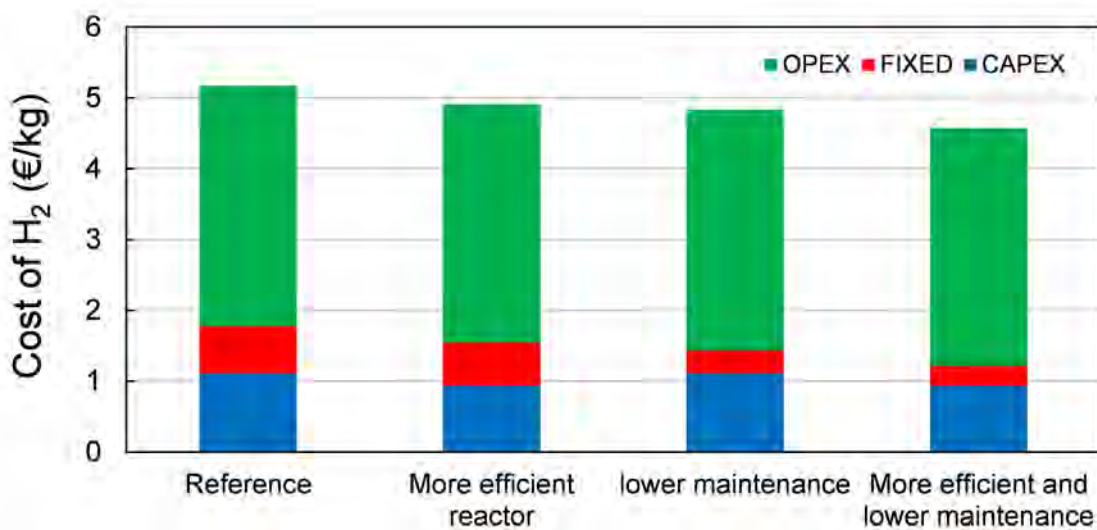

Figure 17: Best case scenarios to improve COH of distributed ammonia reforming unit

3.4. Comparison between distributed and centralised ammonia strategies

In order to evaluate bulk hydrogen import options, two scenarios have been considered, in which imported ammonia is decomposed following either a centralised or a decentralised/ pathway. An overall hydrogen production of 200 te/d is assumed which is either produced in a single unit in the case of centralised cracking or in 1000 dispatched 200 kg/day units.

In the centralised process, ammonia is cracked in large scale ammonia cracking process including ammonia reformer and separation and purification steps as described previously. Pure hydrogen is then pressurized and transported in trailers to point of use. Typically, transported hydrogen is under a pressure between 250 and 300 bar, requiring multistage compression after the ammonia cracking unit. When high pressure hydrogen is delivered to point of use, it undergoes a second compression phase to reach at least 700 bar which is the conventional filling pressure for fuel cell vehicles.

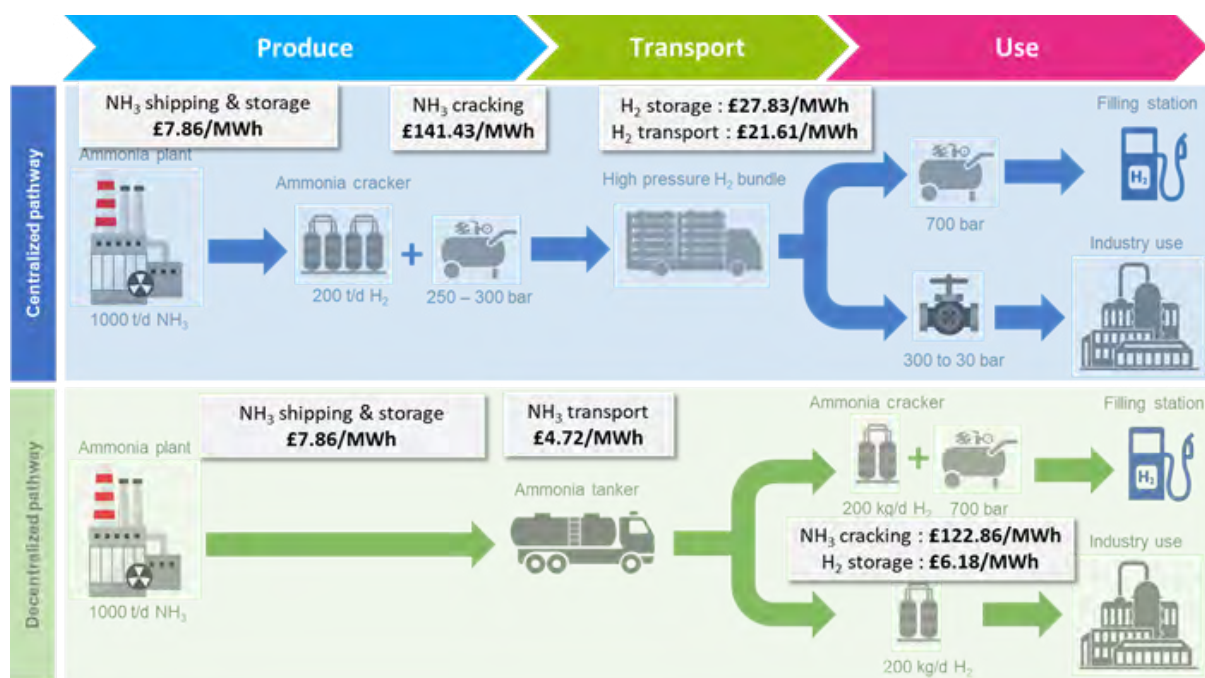

Figure 18: Centralised and decentralised strategies for ammonia decomposition

In contrast, the decentralized pathway does not include a decomposition process of bulk ammonia. Instead, liquid ammonia is transported either using conventional tankers or pipeline grid, a relatively cleaner and safer transport option compared to high pressure hydrogen.. At point of use, ammonia is cracked onsite, using smaller reactors that could be directly integrated to filling stations. Similarly to the centralized case, hydrogen pressure is increased to 700 bar for final use. Another option would be to directly provide low carbon hydrogen to end-use industrial applications. Indeed, most industries, require hydrogen at relatively low pressure. Therefore, a suitable decomposition reactor can be installed to provide hydrogen at low pressure eliminating the energy consumption of compressors required for the centralised pathway.

The results above provide a production cost of hydrogen at £141.43/MWh (including hydrogen compression to 250 bar) for 200te/day and £122.86/MWh for 200kg/day. . To this cost, we add a transport cost of equivalent amount of ammonia from production site to harbour (100 km distance) and from harbour to ammonia terminals by ship (3000 km distance travelled). These costs has been estimated at £7.86/MWh, including costs of ammonia storage. For centralised plants, the cost of storing and distributing the produced hydrogen from cracker to users within a 100km radius is ~ £49.44/MWh (comprising £21.61/MWh transport and £27.83/MWh storage). For decentralised plants, the cost of delivering liquid ammonia to site within the same 100km radius is ~ £4.72/MWh, with storage costs for the hydrogen produced on site ~ £6.18/MWh. This cost comparison in shown in Figure 19.

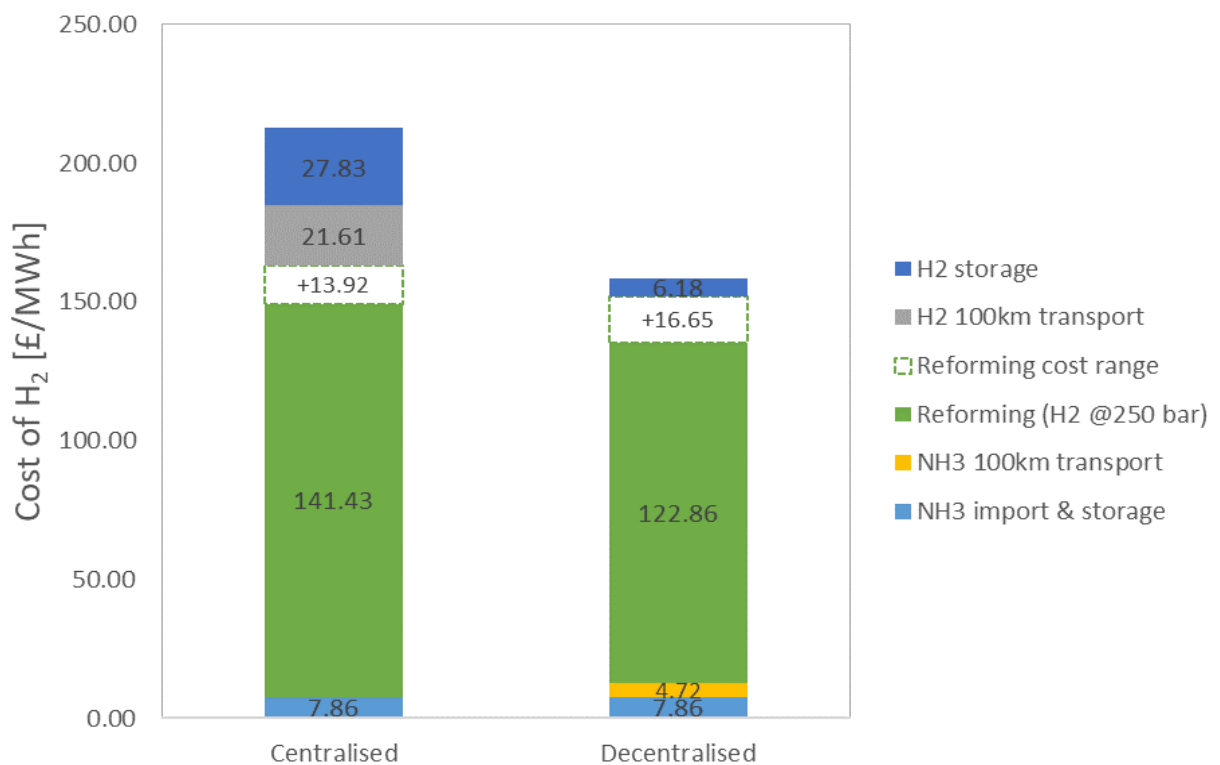

Figure 19: Cost breakdown for both ammonia decomposition strategies

In these two reference cases, the cost of delivered hydrogen to end-users via a decentralised plant rather than a centralised plant is almost 30% lower. This is driven by the costs of hydrogen transportation and storage in the centralised scenario, and the (~30%) lower cost of hydrogen production expected from the innovative membrane technology.

The cost-effectiveness of the decentralisation solution improves further when the distribution radius is widened (see Figure 20). For example, at a distribution distance of 500km, hydrogen production from a decentralised facility would be almost 50% cheaper than from a centralised facility (see Figure 20). This demonstrates the strong potential for ammonia as a hydrogen carrier when it takes advantage of the existing infrastructure for its storage and transportation.

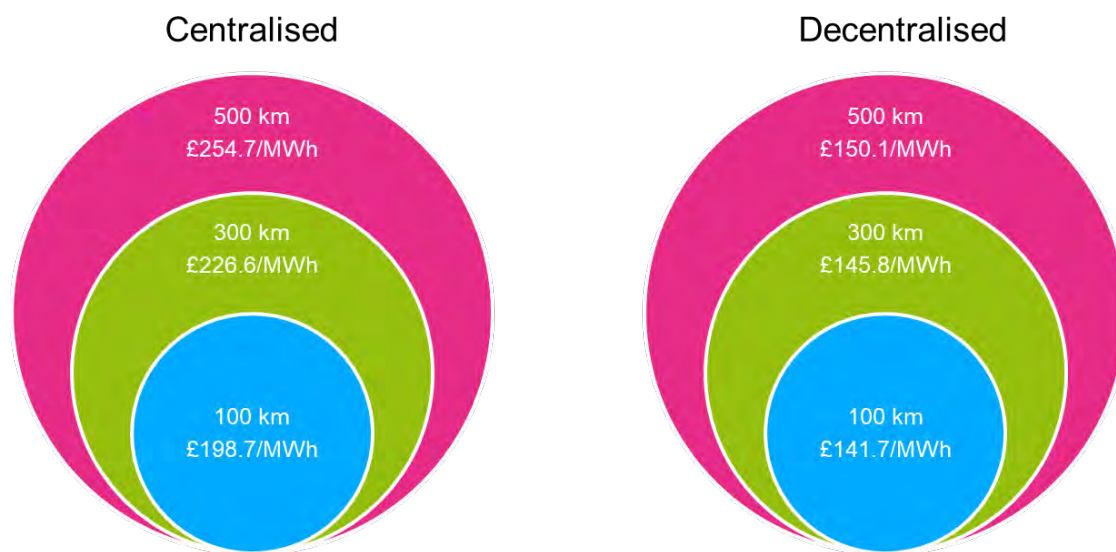

Figure 20: Impact of distribution radius on total cost of delivered hydrogen

4. DEVELOPMENT OF A NEW LITHIUM IMIDE CATALYST

This section will present an assessment of a new lithium imide catalyst and the impact that its use could have on the optimisation of the ammonia decomposition process. This will include:

- 1 An assessment of the catalyst performance
- 2 The design of a 5kg day cracker that would scale up the catalyst and demonstrate its performance

4.1. Catalysing Ammonia Decomposition

Technological maturity is one of the key advantages of the use of ammonia as a hydrogen store; its synthesis and distribution infrastructure has been developed into a global operation over the past century. However, in its existing markets as a fertiliser, refrigerant and in the production of other chemicals, the decomposition of ammonia to release hydrogen is not required. As such, the decomposition of ammonia is arguably the least well-developed component of the ammonia energy storage cycle.

The reaction is thermodynamically favourable above 190°C at atmospheric pressure, but is significantly kinetically hindered, meaning that catalysts are required to promote the production of hydrogen. Most of the research on ammonia decomposition catalysts has focussed on transition metal systems which were of interest for the synthesis of ammonia (1; 2; 3). Ruthenium is widely seen as the most active catalyst, with significant research also on iron and nickel systems, where higher catalyst loadings can make up for the lower activity of these metals on a per atom basis.

Achieving high conversion (>99%) at appreciable ammonia flow rates generally requires temperatures in excess of 450°C (4), giving impetus to investigations into more highly active catalyst materials which may improve the energy efficiency and reduce capital costs of ammonia decomposition reactor systems. Recently, a new family of catalysts developed by STFC have shown significant promise in this area: metal amides and imides, which are salts consisting of (generally) light metals paired with NH_2^- (amide) or NH^- (imide) ions (5; 6). These materials have been shown to have cost and performance advantages to existing transition metal catalysts.

The first system to be examined was sodium amide (NaNH_2), where the catalytic behaviour was rationalised by the successive decomposition and formation reactions of sodium amide via sodium metal (7). While showing promising activity, the volatile liquid form of the catalyst under operating conditions resulted in some complications in containing the catalyst in the reactor.

This issue of catalyst containment was largely addressed by the use of the lithium analogue, lithium amide (LiNH_2) (8). Unlike sodium amide, lithium amide does not decompose to the metal, rather forming lithium imide (Li_2NH). While lithium amide melts, its decomposition product lithium imide remains solid to very high temperature (>600°C), significantly improving the ability to contain the catalyst. Experiments following the structure under ammonia decomposition conditions showed that at high temperatures the catalyst forms a solid mixed amide-imide phase (8).



The lithium amide-imide system showed significantly higher catalytic activity than sodium amide and ruthenium, reducing the temperature of 90% conversion by around 50°C, as shown in Figure 21. It has also been shown to behave quite differently to conventional catalysts, as isotope experiments have shown that all of the nitrogen and hydrogen in the catalyst is able to be exchanged with the reacting gases (8; 9). This indicates a bulk reaction mechanism as opposed to the surface mechanisms understood for transition metal catalysts. This reduces the need for particle nano-sizing and complex catalyst support architectures such as are often needed to achieve the highest activities in metal-based catalysts (10), and also improved the stability of the catalyst towards temperature cycling such as may be required with direct coupling to renewable electricity installations. Furthermore, the feedstock elements are far more abundant than ruthenium. Together with the simpler catalyst formulation, this is likely to result in cheaper catalyst formulations using lithium imide.

Tests of the catalyst operation over ~60 hours showed no degradation in performance (11). The promising activity of lithium amide-imide has been developed into a benchtop demonstration unit (12). In this system, 1 g of lithium imide was used to decompose >99% of a 500 sccm flow of ammonia into hydrogen and nitrogen at 580–600°C. This was purified using a magnesium chloride trap to ensure <0.1 ppm final ammonia content. The gas mixture was then fed into a PEM fuel cell, modified for a mixed hydrogen/nitrogen gas input, to produce a 40 W electric output.

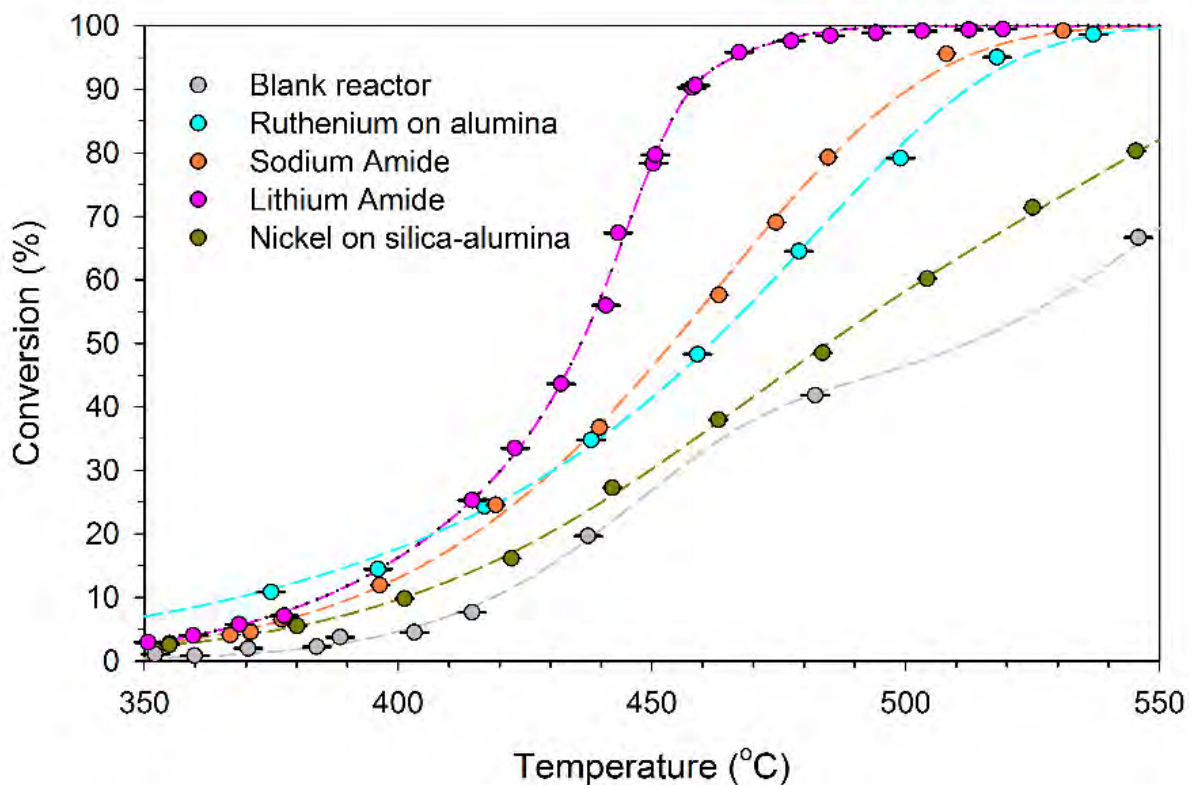

Figure 21: Catalytic ammonia decomposition performance of lithium and sodium amide compared with supported nickel and ruthenium catalysts. Test conditions were 0.5 g of catalyst under 60 sccm of ammonia flow at 1 bar in a 46.9 cm³ cylindrical reactor (height 10 cm). Adapted from [8].

While the demonstration project indicated that the incorporation of lithium imide into a working ammonia decomposition system is feasible, it was far from an optimised system (e.g. it did not have a net energy output). As such a number of important steps have been taken in this feasibility study to explore the scale-up potential of this novel catalyst system from the previous TRL4 system to the 5 kg H₂/day system proposed in this study:

- Scale up of the catalyst synthesis process to an appropriate level for higher-power units, including an appropriate particle morphology for a packed-bed reactor, rather than the flow-over reactor designs which have been used previously
- Design of an integrated ammonia decomposition reactor system with fully integrated thermal management system to maximise performance
- Ensure system complies with relevant safety standards (EN 60079 Explosive atmospheres, PD5500 Pressure Vessels)

4.2. Design of 5kg/day Cracker

4.2.1. System Overview

The main components of the cracker are an evaporator to vaporise the stored liquid ammonia, a preheater to heat the resulting ammonia gas to 400°C and a reactor filled with a packed bed of 1 mm diameter spherical lithium imide pellets where the cracking reaction is catalysed. Heat is supplied to these components from a closed circuit heated nitrogen loop as shown in Figure 22. The mass flow of nitrogen is significantly higher than the mass flow of ammonia which facilitates the high heat flux required to feed the endothermic cracking reaction without a huge variation in temperature across the reactor. The ideal scenario for the catalyst is to operate at near to a constant temperature. After the nitrogen has provided heat to the reactor, pre-heater and evaporator, it is still significantly above ambient temperature but this heat left in the nitrogen is not lost by virtue of the closed loop.

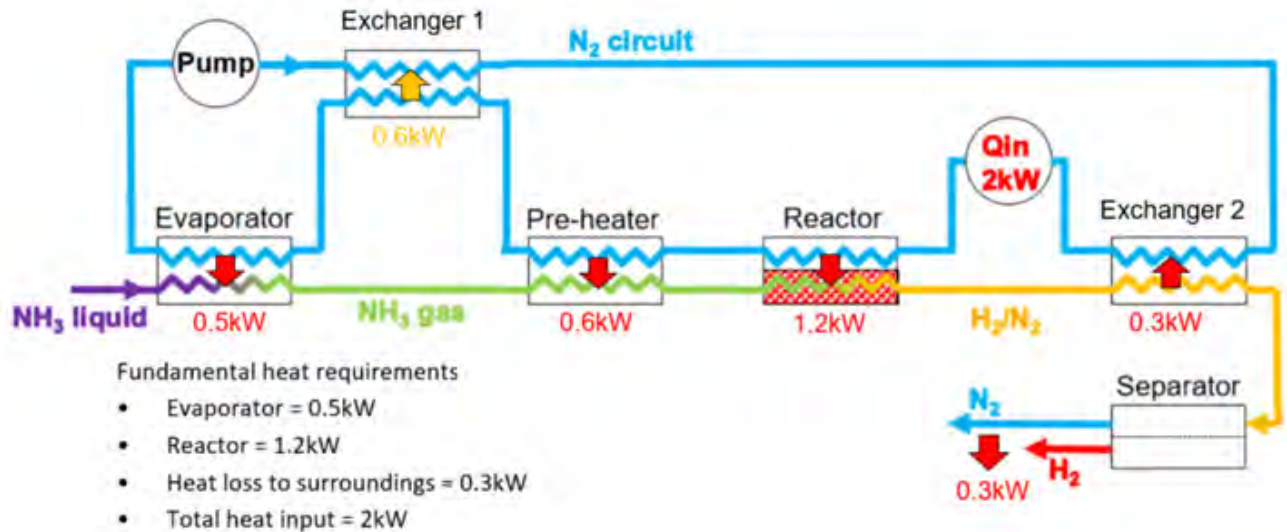

Figure 22: Ammonia Cracker System Diagram Schematic (heat flows are during steady state operation)

The nitrogen loop features two additional heat exchangers. Exchanger 1 is used to shunt heat across the nitrogen circuit having the effect of lowering the nitrogen temperature at inlet to the pump to below the maximum pump operating temperature. Exchanger 2 recovers heat from the cracked ammonia to suit the requirement of the separator and to maximise thermal efficiency. The nitrogen heating loop also facilitates an inherently safe design where high temperature cracked hydrogen is separated from the heat source whether that be an electric heater, as in the 5 kg/day demonstrator, or the flue gases of an ammonia burner, as would be the case in a commercial scale cracker.

The decomposition reaction does not yield complete conversion of ammonia into hydrogen and nitrogen. A small quantity of ammonia is expected to remain in the outlet gas stream. This, along with the 25% nitrogen content (by volume) of the outlet gas stream must be removed through a separation and purification system to increase the purity of hydrogen to the level required for PEM fuel cell use. This is to be achieved through the use of a palladium membrane separator.

The decoupled nature of the cracker and separator provides the opportunity to optimise the hydrogen purity - cost relationship. For example, if the application only demands moderate purities (i.e. heating) other separation methods may prove more economically viable. Polymeric membrane performance simulations conducted by UniSieve identified nitrogen could be selectively removed to achieve a purity of 98% in a single stage. By utilising only the pressure contained in the cracked ammonia gas, a suitable grade of hydrogen could be produced with no additional energy input, potentially resulting in a significant increase in system efficiency.

Variable production rates are achieved by altering the ammonia and nitrogen loop flow rates. To produce less hydrogen, less ammonia is needed. As a lower energy input is required for cracking, the nitrogen flow rate is reduced to lower the heat transferred whilst maintaining a constant operating temperature. This provides great production flexibility and has little effect on the system efficiency.

A model of the 5 kg/day cracker has been produced based upon the presented system schematic. To minimise thermal losses and increase system safety, the majority of components are to be contained within a vertically mounted cylindrical vacuum vessel. In addition to providing superior thermal performance, the vacuum vessel also allows any leaks to be easily detected and dealt with by the control system. The tubular double-pipe cracker components are mounted to a suspended support structure. Two concentric radiation shields are also fixed to this support to reduce radiation losses. Radiation shielding is extremely effective, reducing the radiative heat loss to 60 W. A controllable 4 kW electric heater is centrally mounted within separate vacuum vessel at the centre of the main chamber.

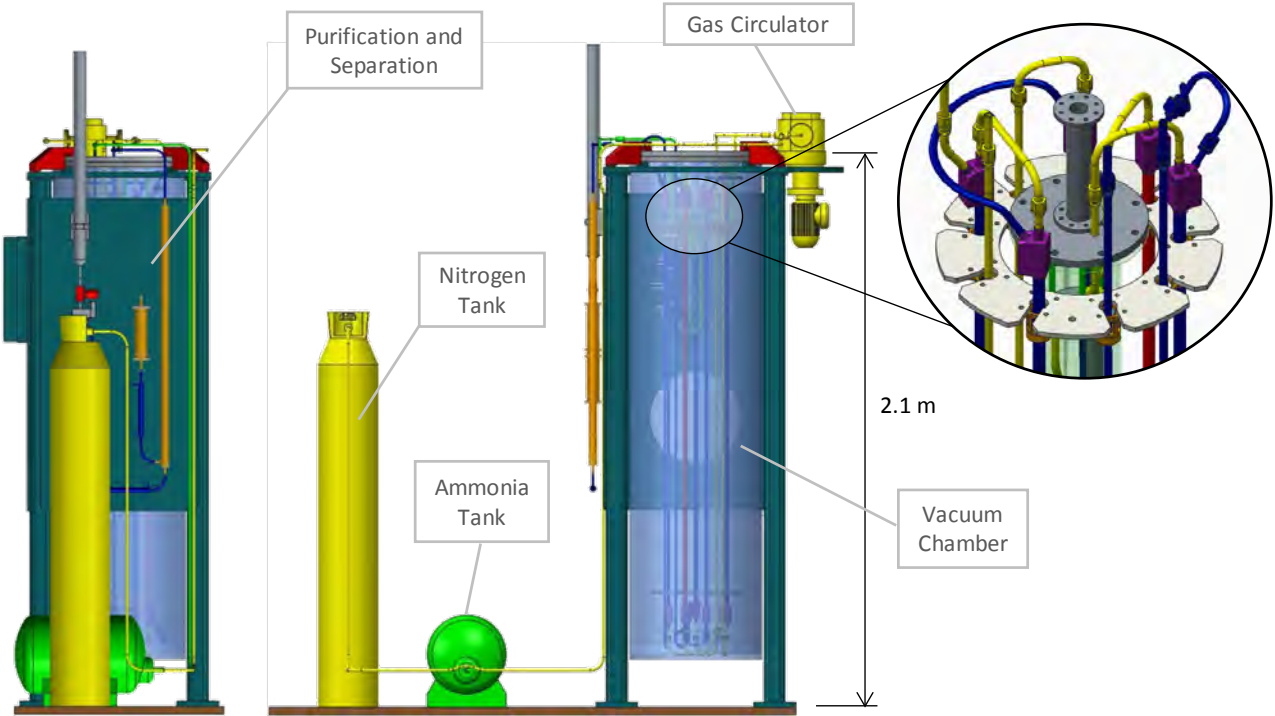

Figure 23: 5kg/day Cracker CAD Model

The engineering design and the thermal management system of the 5 kg/day cracker serves to demonstrate the feasibility of efficiently cracking ammonia with a lithium imide catalyst at any scale. The design is scalable with a larger capacity achievable by adding more reactor and evaporator tubes in parallel and thus still respecting the thermal and safety design constraints determined within this study. While an electric heater was chosen for this small scale demonstrator for convenience, cost and safety, an ammonia burner is the only economical and environmentally viable option for providing the required heat at any commercial scale. The only fundamental difference between this design, and a larger scale cracker, is that flue gas from the ammonia burner would be used to heat the nitrogen via a heat exchanger instead of direct electric heating of the nitrogen. An additional recovery heat exchanger would be used to pre-heat the flow entering the ammonia burner to maximise efficiency as shown in Figure 24.

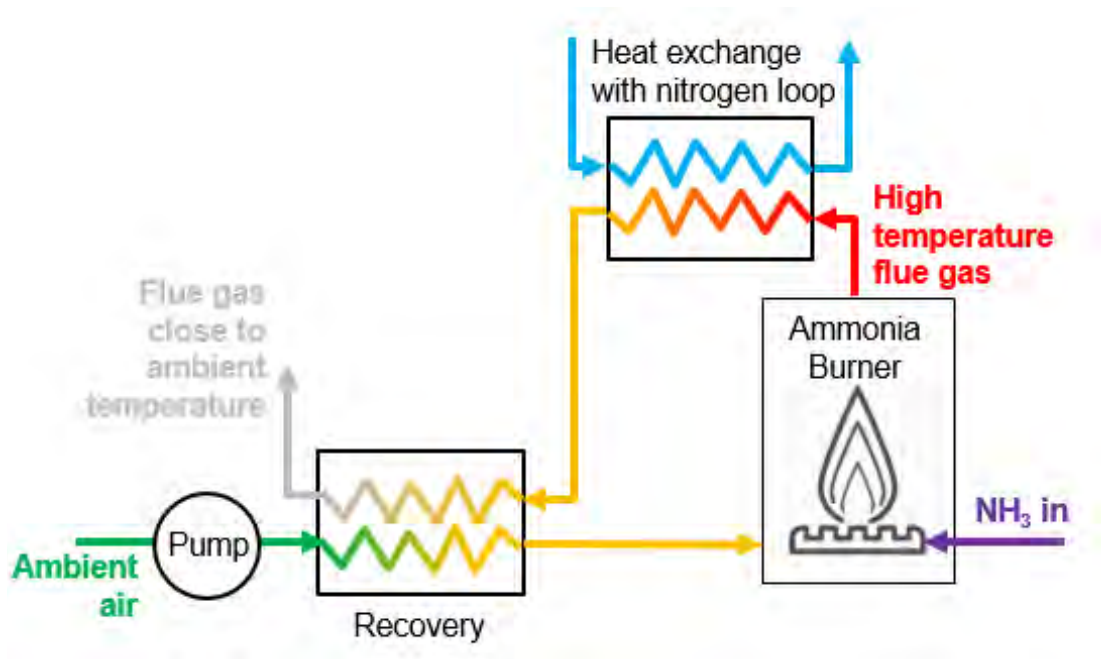

Figure 24: Schematic of ammonia burner for efficient large scale cracking

4.3. Cracker Model

A coupled computational fluid dynamic model of the evaporator, ammonia preheater, reactor and heat exchanger 1 has been developed as a design tool enabling the prediction of the cracker's operational characteristics. All of the double pipe components are made from stainless steel (316L) with internal pipe diameter of 10 mm and external pipe diameter of 17 mm. This material is selected as it gives good resistance to hydrogen embrittlement and corrosion (13).

The evaporator has liquid ammonia entering the central pipe at the bottom and hot nitrogen flows down the annular section (Figure 26a). The evaporator model includes heat transfer between nitrogen, the tube walls and the ammonia, phase change of the ammonia and buoyancy effects due to density difference between ammonia liquid and vapour. The nitrogen gas enters the evaporator at 250°C and leaves at 130°C while the liquid ammonia enters at 20°C and leaves as a vapour at an average temperature of 48°C (Figure 26b). Good heat transfer is achieved along the full length of the evaporator by virtue of the fact that there is always at least 100°C difference between the nitrogen and ammonia.

The reactor model includes conjugate heat transfer, ideal gas assumption for the ammonia, nitrogen and hydrogen and an ideal mixture mass averaging assumption to determine transport properties of the mixture. The ammonia catalyst channel is modelled as a porous domain containing 1 mm diameter catalyst pellets with flow resistance coefficients based on the Ergun equation. The heat transfer between the gas and the catalyst pellets is calculated from an empirical Nusselt number correlation for heat transfer in packed beds. The decomposition of ammonia in the catalyst is modelled using the following rate equation which has been determined from experiments:

$$r = 2.92 \times 10^6 \cdot p \cdot m_{f_{NH_3}} \cdot e^{\frac{-17020}{T}} \quad [\text{mol(NH}_3\text{) g}^{-1} \text{ cat s}^{-1}]$$

Where p is pressure [bar]; $m_{f_{NH_3}}$ is mass fraction of ammonia and T is temperature [K].

The mass of catalyst pellets required to achieve the desired conversion percentage is found to be 100 g. The nominal temperature of the nitrogen entering the reactor heating channel is 770°C which is required to provide adequate heat transfer into the catalyst to maintain it between 400°C and 550°C. The reactor model has shown that the disassociation is heat transfer limited rather than limited by the chemical rate equation. The total endotherm for the mass flow of ammonia is 1220 W, which means the system needs to nominally provide 9 W/cc of heat to the catalyst to maintain a steady temperature. In order to achieve this heat flux and ensure complete utilisation of the catalyst, there must be adequate heat transfer across the catalyst perpendicular to the ammonia flow direction. Figure 25a shows a schematic view of the catalyst bed with the critical dimensions of length and width. Heat is applied from one side of the reactor along its entire length. The transverse diffusion of heat from the hot surface through the packed bed depends on the conductivity of the gas plus the level of turbulence and gas mixing (14).

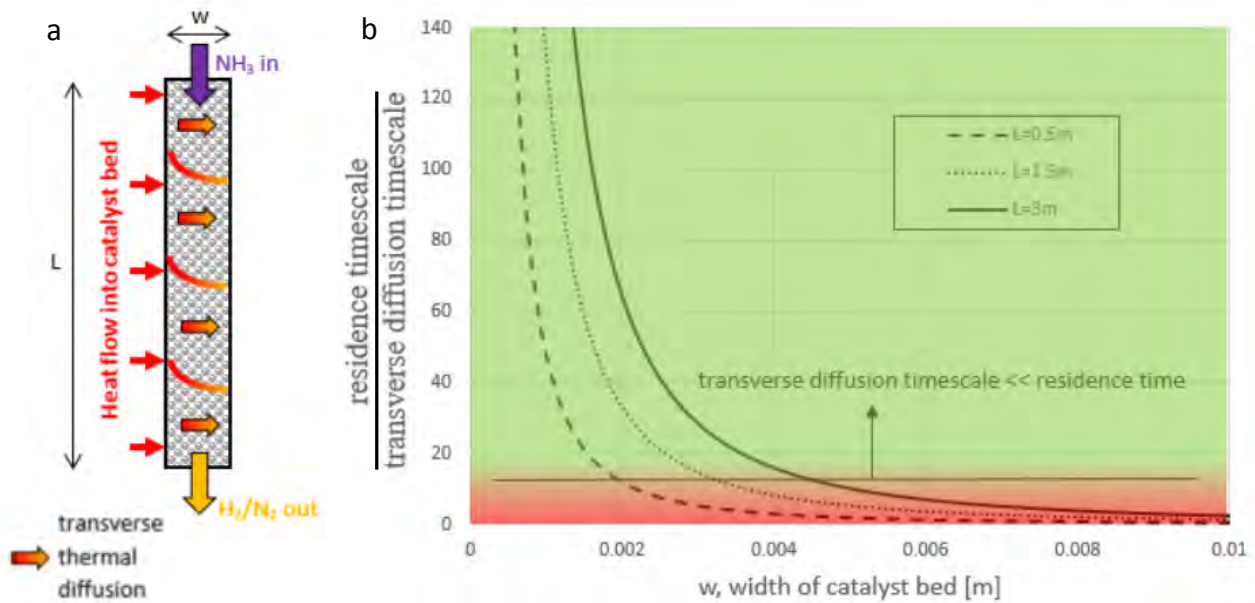

Figure 25: a) Schematic of packed catalyst bed showing critical dimensions and transverse heat flow across applied from one side, b) Maximum catalyst bed width for complete utilisation of catalyst

Figure 25b shows the ratio of residence time (channel length over fluid velocity) to transverse diffusion time, as a function of catalyst bed width and for three different lengths. This ratio needs to be greater than 10 to achieve complete utilisation of the catalyst. As w and L are varied, the volume of the catalyst is kept constant at $7.36 \times 10^{-5} \text{ m}^3$ (required catalyst volume to produce 5 kg/day of hydrogen). As the reactor length is reduced the flow area must be increased in order to maintain catalyst volume. This results in lower flow velocity and turbulence and slower transverse diffusion of heat. It can be seen that a shorter reactor requires a narrower catalyst channel to ensure complete catalyst utilisation. A reactor length and width of 1500 mm and 2.5 mm respectively has been chosen as shown in Figure 26c. The CFD model of the reactor shows that we nominally achieve complete disassociation of the ammonia flow, Figure 26d, resulting in a hydrogen mass fraction of 0.18, Figure 26e, and a nitrogen mass fraction of 0.82 at the outlet of the reactor.

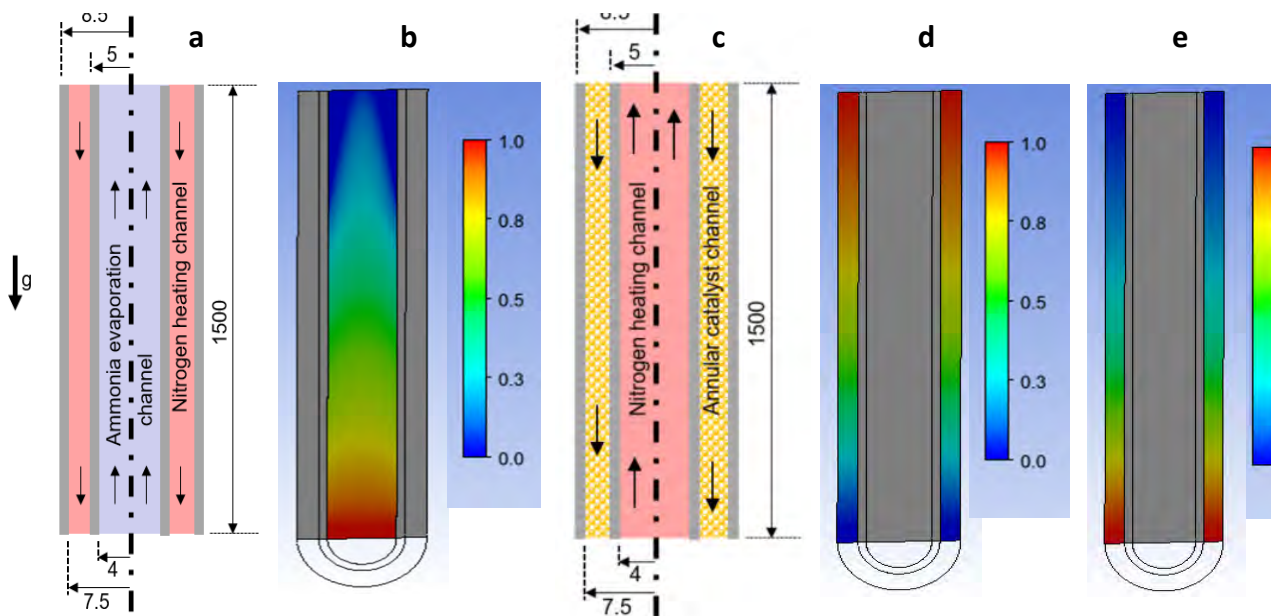

Figure 26: a) Schematic of ammonia evaporator b) ammonia liquid mass fraction in evaporator c) schematic of cracking reactor d) ammonia mass fraction in catalyst channel e) hydrogen mass fraction in catalyst channel

Both the preheater and heat exchanger 1 have been modelled as double pipe heat exchangers with the same dimensions as the reactor and evaporator and these four main components have been linked together to make the coupled thermal model. Figure 27 shows the temperatures of nitrogen and ammonia throughout the coupled thermal model and indicates that we can achieve critical temperatures such as the ammonia inlet to the reactor and nitrogen inlet to the pump. If the catalyst is exposed to ammonia significantly below the activation temperature it can result in catalyst deformation, increasing pressure drop or blocking the channel. It can be seen that a reactor inlet temperature of 400°C is achieved which is high enough to ensure cracking starts as soon as the ammonia vapour enters the catalytic reactor. It should also be noted that the temperature of nitrogen at inlet to the pump is 130°C which is within specification for the nitrogen pump. Figure 27 also highlights the uniform catalyst temperature that is achieved with this design despite the high heat flux being delivered to the endotherm. Operating the nitrogen circuit at an elevated pressure of 10 bar significantly reduces the pressure difference required to circulate the nitrogen and also the duty on the pump and its power requirements, compared to running at nominal atmospheric pressure.

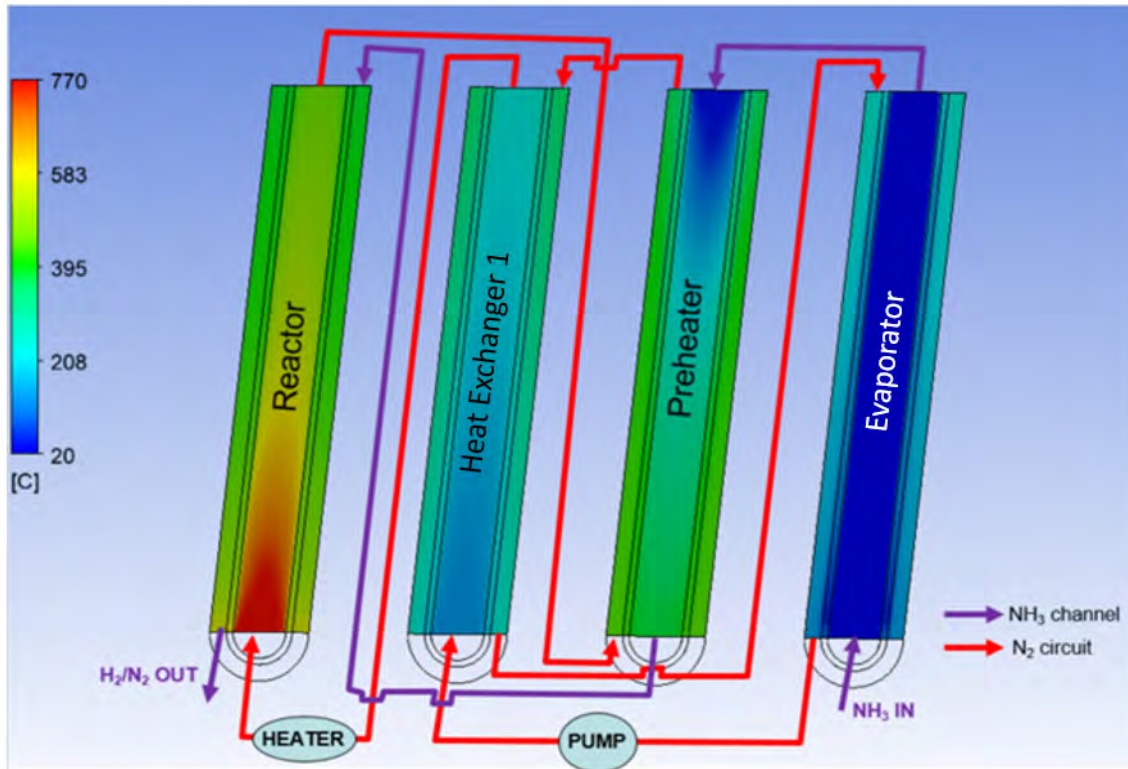

Figure 27: Temperature in coupled thermal model of main cracker components

4.4. Performance and Economics of the 5kg/day Cracker

4.4.1. Efficiency Considerations

An estimate of the energy cost of cracking ammonia was generated from thermodynamic analysis of the design. The endothermic reaction and the evaporation of ammonia are unavoidable thermal requirements and together make up 49% of the cracker energy consumption. Component thermal losses, power consumed by the nitrogen pump and heat exhausted with the outlet cracked gas amounts to 20% of the cracker energy requirements. Some loss of hydrogen is expected due to imperfect recovery in the separation and purification section and this amounts to an equivalent of 6% of the energy consumption. The final 25% of the energy requirement is taken up by compressing the hydrogen to 30 bar. The total energy consumption for cracking and pressurising the pure hydrogen to 30 bar is calculated to be 96.6 kJ/mol of hydrogen produced. This equates to 33.8% of the calorific value of the hydrogen based on the HHV. In summary we predict the total power consumption of the cracker to be 2.8 kW for a hydrogen delivery of 5 kg/day or 8.2 kW (equivalent calorific value of hydrogen based on HHV).

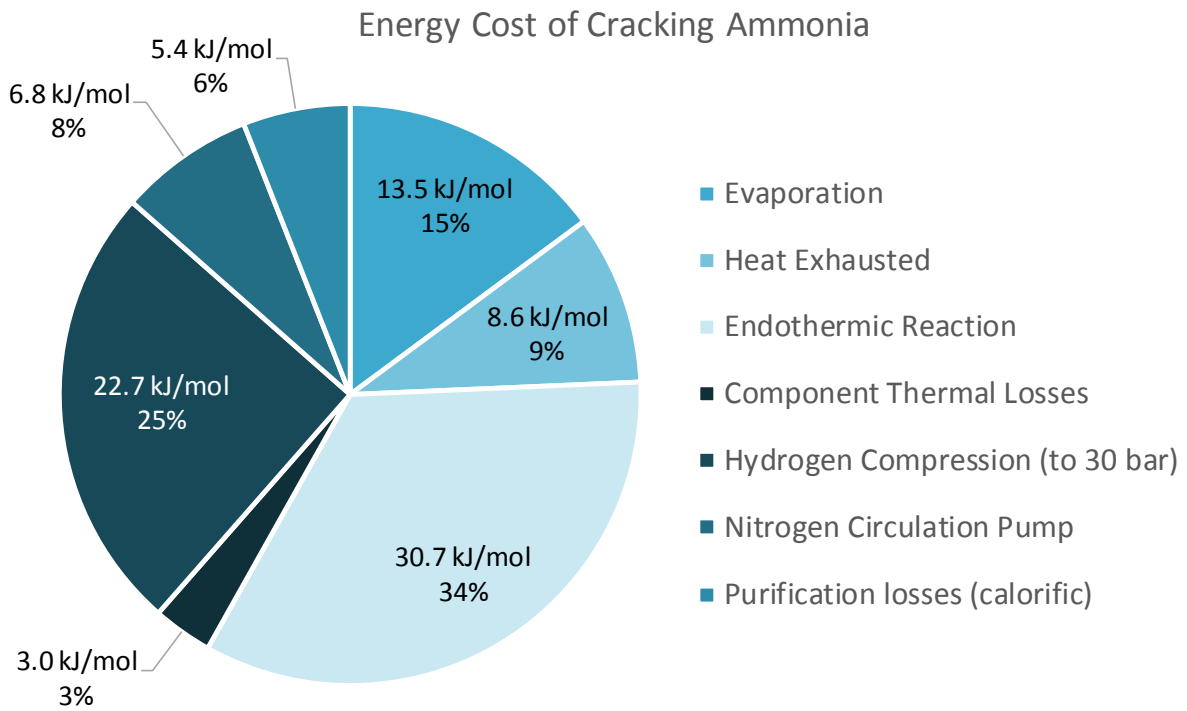

Figure 28: Breakdown of energy consumption associated with cracking ammonia, units of kJ/mol of hydrogen produced

4.5. Cost Estimate

A summary of the estimated total cost for completion of the detailing, construction, commissioning and testing of the 5 kg/day cracker is given in table 4.

Table 4: Summary of Cost Estimate for Phase 2 Scope

		Cost
Capital Expenditure	Mechanical components	£207,000
	Control system	£45,000
	Safety approval/ consultants	£38,000
	Total	£289,000
Operational Expenditure	Green ammonia plant facility charge	£126,000
	Additional on-site equipment & operating costs	£38,000
	Total	£164,000
Design/ Manufacturing Effort	Total effort cost (including overheads)	£1,084,000
Travel	Supplier visits	£12,000
	Conference	£ 4,000
	Total	£16,000
	Grand Total	£ 1,553,000

A key factor in the viability of using ammonia as an energy transport medium is the cost of synthesis and decomposition. For this to be considered a viable storage medium, the cost benefit to transportation and storage must exceed the cost associated with producing an intermediate storage of hydrogen as ammonia. A significant fraction of the operational cost of the cracker is the cost of energy input, the majority of which is heating. In the case of the 5 kg/day demonstrator, this is an electricity cost, however this could equally be translated to a sacrifice of hydrogen or ammonia in a larger system with a gas burner. The 5 kg/day ammonia cracker requires a continuous energy input of approximately 3 kW. Assuming an Energy cost per kWh of £0.07, this gives an electricity cost per kg of hydrogen produced of £1.00. The energy consumption cost is equivalent to £25.4/MWh of hydrogen released. We would not necessarily expect this cost to be competitive with large scale crackers because this is primarily a technology demonstrator and because of the use of electricity to provide the required heating.

An estimate of annual operational expenses excluding labour (in additional to ammonia synthesis cost) can be seen in Table 5.

	Item name	Description	Cost (per Item)	QTY	Contingency	Cost
Material/Gas Supply	Anhydrous Ammonia	Intend to use ammonia generated from Haber-Bosch ammonia synthesis. Worst case cost penalty would be to purchase supply of ammonia at cost of £421.30/tonne.	£421.30	10.59	1.5	£6,695.26
	Nitrogen Purge Gas	Used during start-up and shutdown to remove residual ammonia/hydrogen and pre-heat cracker. Cost allows for 26 purges per annum (once every fortnight)	£998.92	1	1.5	£1,498.38
	Magnesium Chloride	4 kg of MgCl ₂ should give time between regeneration of 7.2 days, assuming replacement after 50 cycles, should give approx. 1 years of life.	£4.13	1	2	£8.26
Electricity	Vacuum pump	Pump for primary vacuum vessel assumed 550W at 10% duty cycle.	£38.42	1	1.5	£57.63
	Nitrogen Circulator	Hot nitrogen loop has circulator, 200 W considered conservative power estimate more expensive option runs at 25 W.	£122.64	1	1	£122.64
	Nitrogen Heater	Heater for closed nitrogen loop, requires continuous power of 2.03 kW	£477.18	1	1.25	£1,585.40
	Hydrogen Compression	Outlet hydrogen compressed from atmospheric to 30 Bar intermediate pressure, compressive power is 780 W.	£477.18	1	3	£1,431.55
Maintenance	Pipework	Pipes operating above 450 C are expected to see sufficient creep during lifetime to require replacement ever 10 years	£3,500.00	0.1	1.5	£525.00
	Circulator maintenance	Maintenance estimated at 10% of capital expense per annual	£2,500.00	1	1	£2,500.00
	Heater	Expected heater lifetime of 6 months, results in bi-annual replacement	£1,000.00	2	1	£2,000.00
	Catalyst	Replacement of catalyst & reaction chamber every 5 years	£6,000.00	0.2	1.5	£1,800.00
Total cost						18,224.12

Table 5: Annual Operation Cost Estimate of Ammonia Cracker

4.6. Next Steps in Development of the Cracker

The next stage of development of the cracker is to raise the TRL of a lithium imide based ammonia cracker from 4 to 6/7 by demonstrating and validating the feasibility of the technology developed. This includes understanding how the whole system behaves, but also specifically determining the performance of the catalyst and separation technology, through testing.

The first phase of testing focusses on testing the system at steady state conditions. This involves running the system conservatively, i.e. operating the catalyst at higher temperatures, using more catalyst than strictly necessary and operating the palladium membrane at optimal conditions. This ensures that all parts of the system can be monitored to assess their combined behaviour with a minimised risk of process failure. Additional process risks have been identified which will need evaluating during the first phase of testing, in the form of a risk register. Risks such as catalyst degradation and membrane robustness have been highlighted. Mitigation, risk response and monitoring strategies have also been noted to reduce risk probability and impact.

Once the system has been successfully operating under 'low risk' conditions, and the operating procedures have been fine-tuned, additional tests will be undertaken to assess the performance envelope of the ammonia cracker. This will include:

- Variable hydrogen production rates
- Analysing the effect of reduced catalyst temperature on hydrogen quality
- Lifetime tests – running the system for extended periods
- Membrane robustness – varying temperature and pressure

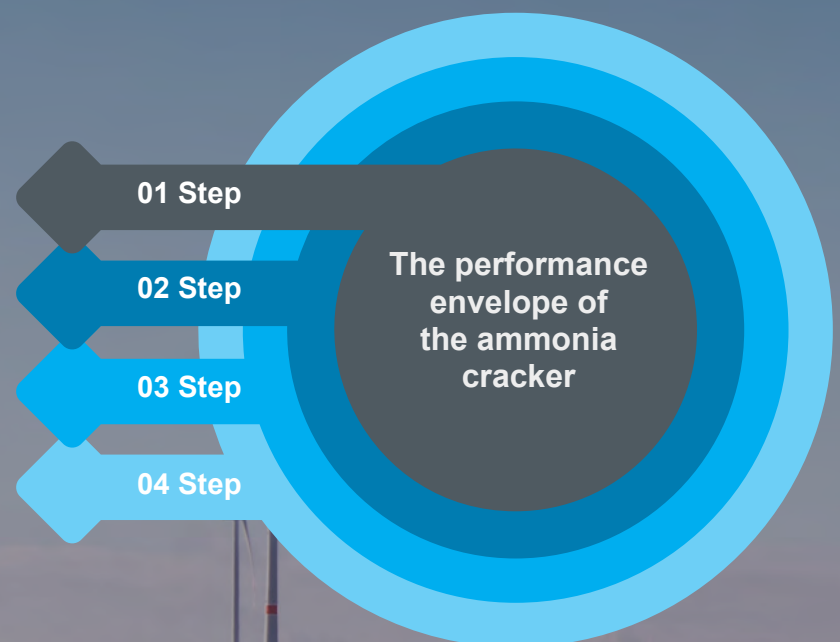



5. MARKET ASSESSMENT

In this section, an assessment of the market potential for the solution will be presented. This will include:

1

Identification of key markets for the solution presented in this feasibility study

2

The commercialisation pathway for the technology in the UK

5.1. Key markets

Within the Industrial Strategy, the UK government has developed The Clean Growth Strategy which sets out the actions that the UK will take to cut emissions, increase efficiency and lower the amount that consumers and businesses spend on energy (33). Hydrogen is referred to in The Clean Growth Strategy as a clean fuel which could be used for transport, industry and heat in Pathway 2, one of three low-regrets pathways to support an 80% reduction in emissions by 2050.

The strategic challenge for the UK to decarbonise arises from its high dependency on natural gas for both heat and electricity generation. Heat generation is cyclical on a seasonal basis and electricity generation is variable over a full range of timescales.

According to the Committee on Climate Change, Hydrogen is a credible option to help decarbonise the UK energy system (15). Used selectively, alongside widespread electrification and improvements to energy efficiency, hydrogen has potentially valuable roles in replacing natural gas (e.g. for heating buildings on colder winter days, industrial process heat and back-up power generation) and liquid fuels (e.g. in heavy transport). Critically, the CCC stress that if hydrogen is to play a substantial long-term role, deployment of low-carbon hydrogen at scale must start now. Deployment of hydrogen should start in a 'low-regrets' way over the next decade, recognising that even an imperfect roll-out is likely to be better in the long term than a 'wait-and-see' approach that fails to develop the option properly.

In the UK, the annual cost of achieving 100% reduction in greenhouse gas emissions by 2050 would amount to 1-2% of GDP to 2050. This is the same cost as the previous (legislated) expectation for an 80% reduction (in GHG emissions) from 1990. While the cost to this transition may be substantial, this shift has several economic benefits – faster economic growth, more jobs and improving social welfare.

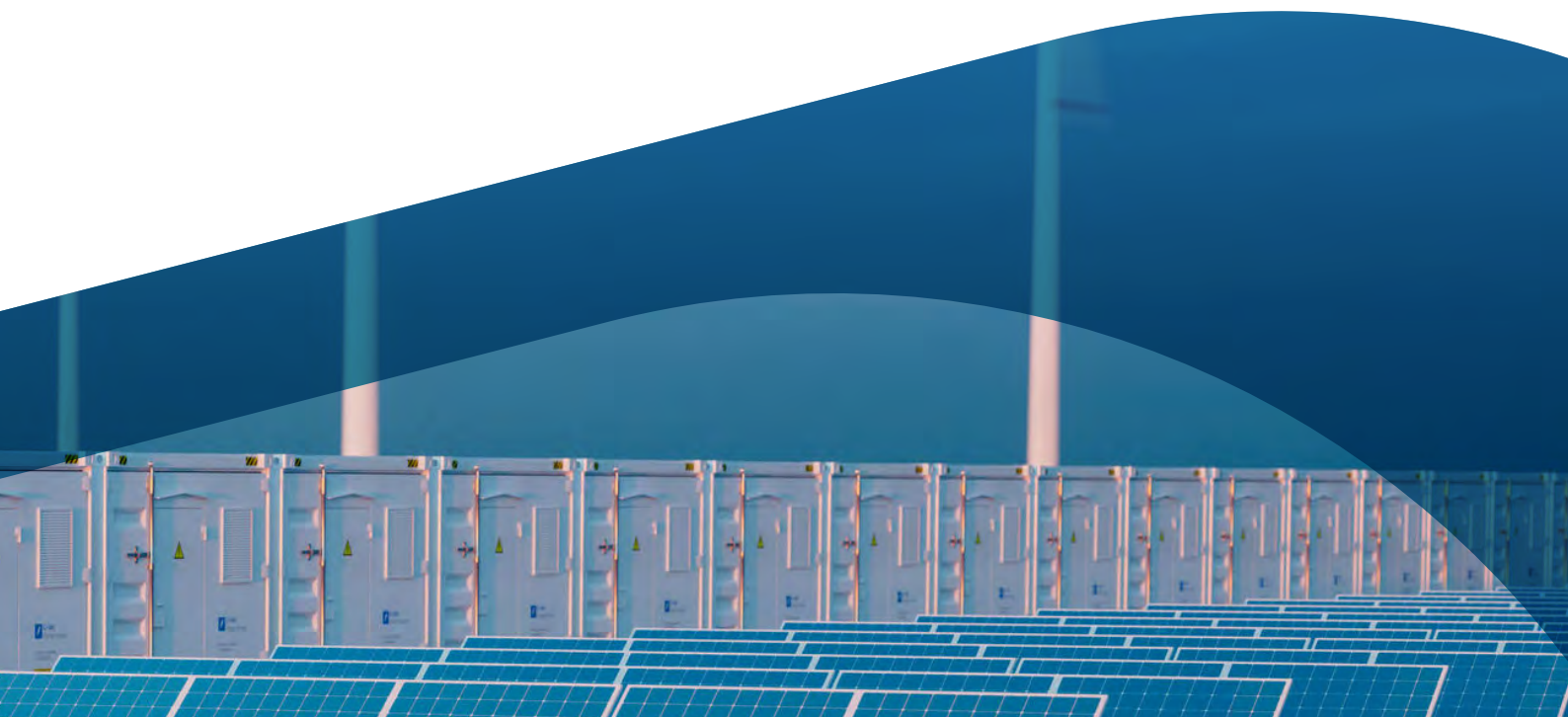

This energy transformation would reduce human healthcare costs, environmental damages and subsidies bringing annual savings by 2050 of between three and seven times the additional annual cost of the transition. By 2050, this shift would provide a 2.5% improvement in GDP and a 0.2% increase in global employment, compared to business-as-usual. For every £1 spent on the energy transition, there would be a payoff of between £3 and £7 – or, put in cumulative terms over the period to 2050 – a payoff between £53 trillion and £130 trillion (34).

As with the usual uptake of new technologies, the penetration of hydrogen into appropriate sectors will not occur uniformly across the board, but first in sectors that will tolerate initial higher costs and where the transition to hydrogen will cause a minimum of disruption to the activities of end-users, thus lowering the barriers to entry.

The three broad markets where hydrogen uptake is both feasible and achieves the maximum CO₂ reduction are heating, transport and stationary power generation/energy storage. Based on current DUKES data (35) the total annual market size based on current retail energy prices per kWh are: heating with natural gas (£16.2bn total market size, based on 2.8p/kWh retail price), electricity (£37.5bn total market size, based on 12.5p/kWh) and road transport (£80bn total market size, based on 12.5p/kWh (£1.25/l, 10kWh/l)). From this the largest markets at the highest current price per kWh are ranked in the order: transport > electricity > heating. It is thus logical to identify the most promising sectors within the largest and most cost tolerant markets to target first for market penetration.

5.1.1. Transport sector (UK market size £80bn)

The future transport fleet will consist of several different technologies operating side by side with the relative proportions of each determined by factors such as state of technology development, cost, satisfaction of end-user needs and legislation. The drive for lower emissions of CO₂ and pollutants such as NO_x and particulates will result in an increasing use of electric drive trains, some of which will be powered by batteries and some by hydrogen and fuel cells. Batteries have a benefit of being of lower cost than hydrogen/fuel cells, but this gap will narrow over time, resulting in an increasing penetration of the H₂/FC technology. Despite the cost difference, H₂/FCs have features which are valued by end-users; namely their fast refuelling capability and their long-range capability without compromise of load/passenger carrying space. This results from a substantially higher energy density by weight and volume for H₂/FC systems compared to batteries. The limited energy carrying capabilities of batteries prevents their widespread adoption in coaches, HGVs and trains which require long range and continuous operation, and this is where H₂/FCs are expected to make significant market penetration.

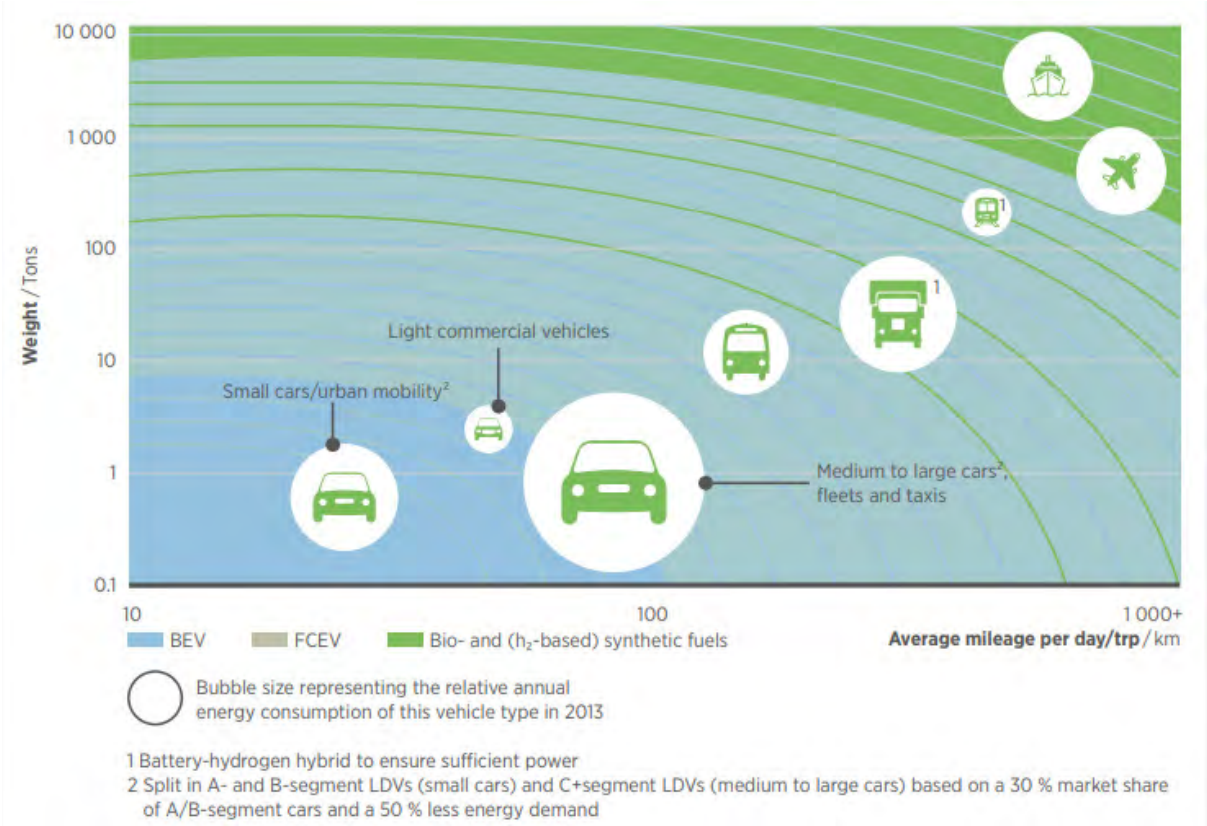

Figure 29: Segmentation of the transport market (36)

Over time and as volumes develop, the cost difference between fuel cells and batteries will decrease and a point will be reached at which the benefits of the fuel cell system outweigh the additional cost and fuel cell passenger cars will form a significant part of the transport mix. The IEA has reviewed the announcements FCEV deployments by several key countries (37) and these suggest that widespread deployments are likely to be towards 2030.

A critical feature of the road transport sector is the widespread and highly distributed nature of the refuelling station infrastructure, with no existing centralised pipeline infrastructure to distribute any kind of liquid or gaseous fuel to the stations. This situation is easily addressed at low cost with liquid ammonia tankers distributing the feedstock to on-site refuelling station crackers, in much the same way as road tankers currently distribute liquid petroleum fuels to forecourts.

While the future prospects for zero-carbon hydrogen refuelling (enabled by green liquid ammonia distribution) of a range of different sized fuel cell powered vehicles appears promising, more immediate applications could help to facilitate a quicker acceptance and uptake of the new refuelling infrastructure and drivetrains. More specifically, there is an urgent need to decarbonise and eliminate unhealthy criteria pollutants, such as NO_x and particulates, from heavy duty transport in and around ports, adjacent conurbations and heavy industrial centres (very often in/adjacent to ports in the UK). In many cases these early implementation locations would also be points of entry of future large-scale imports of internationally sourced low-cost green ammonia or also sites of local indigenous production of ammonia.

This serendipitous close physical collocation of both a high-volume source of green ammonia, as well as a large demand for the zero-carbon hydrogen derived from the ammonia would further facilitate a more facile implementation of the new green-ammonia zero-carbon hydrogen supply chain.

5.1.2. Stationary electricity generation and energy storage (UK market size £37.5bn)

Without a practical means of large-scale energy storage, a zero or low carbon energy system would need to match supply with demand in real time over large distances. This is true of electricity generated by renewables and zero/low carbon hydrogen or other synthetic energy carriers in the gas grid. The National Grid puts out a range of services to tender, ranging from very fast enhanced frequency response (< 1 sec) through to longer duration operating reserve and the capacity market. The faster response services tend to attract higher prices, but only comprise a rather small market size. The very much larger longer-term capacity market attracts lower wholesale prices and tends to be dominated by more conventional type baseload generators, although with increasing penetration of renewables. This increasing proportion of renewables on the grid, as well as the retirement of many older large spinning generators (mostly fossil fuel fired) has reduced the grid inertia, reducing grid stability (frequency control, voltage control) and necessitating more response services to maintain grid stability.

Whilst the latest generation of battery technology has been successfully implemented to provide rapid response services for short durations (for no more than a few hours), it is also technically feasible to provide these services with hydrogen fuel cells (with hydrogen from green ammonia). A key advantage of the hydrogen technology is that it is also capable of providing much longer duration services: eg., diurnal, weekly, monthly and seasonal storage/ electricity generation (enabled by large volume storage of hydrogen/energy dense liquid ammonia). In principle, this enables hydrogen (green ammonia) based energy storage and electricity generation solutions to value stack with several revenue streams, enabling more economically attractive NPVs (net present values).

5.1.3. Heating (UK market size £16.2bn)

The final large market size is heating (decarbonisation of the gas grid). Whilst this market is the least attractive in terms of overall size and cost sensitivity, it is also a very large contributor to the UK's CO₂ emissions and is therefore a priority to address on the path to 2050 Net Zero. Many studies have concluded that the options to dramatically decarbonise the gas grid are quite limited, with substitution of very large volumes of natural gas by green hydrogen being the most likely solution to utilise the existing gas transmission, distribution and end-user infrastructure.

It is estimated that the necessary low-cost basis needed for heating will only be achieved once a large low cost zero-carbon hydrogen supply chain and infrastructure have been successfully implemented, facilitated by the above two earlier market applications (transportation and electricity generation/energy storage).

5.2. Commercialisation Pathway

Hydrogen has the potential to provide a substantial contribution to the goal of net-zero by 2050, but for this to be realised, challenges related to cost reduction in the production, storage and distribution of hydrogen need to be overcome. The widespread adoption of hydrogen as an energy carrier will develop from initial applications which have economics that can justify private investment.

The Commercialisation Pathway adopts a stepwise approach to market penetration and increasing scale of deployment. The market penetration strategy has initial focus on the highest added-value applications of hydrogen, where higher costs can be borne, to progressively lower-added value applications of increasing scale. The increased scale and the application of the technological improvements developed by the consortium will result in sustainable profitable operation and attractive investment opportunities for large scale deployment of hydrogen and the consequent benefits for CO₂ reduction, air quality and economic prosperity.

The Pathway will establish end-users and investors in a succession of applications of increasing scale, leading to a significant contribution to the net-zero target by 2050, as follows:

1. Substitution of a substantial proportion of hydrocarbons currently used as transport fuel, especially in larger transport modes such as buses, trains, HGVs and ships
2. Provision of substantial capability to store large amounts of UK generated renewable energy for power generation and grid balancing over short, medium and seasonal timescales
3. Displacement of a significant proportion of current imports of natural gas and liquefied petroleum gases (LPG) for heat, providing access to very low-cost renewables and/or SMR/CCS in locations such as the Middle East, Australia and North America.

Successful commercialisation depends on the ability to demonstrate that the concept of producing zero/low carbon hydrogen, converting it to ammonia for storage and/or transport to end-users and its subsequent reconversion (cracking) back to hydrogen can be achieved in practical terms, with economics that are superior to the currently favoured methods of on-site electrolysis or large-scale centralised production and distribution. The concept is helped by the fact that the ammonia production, storage and transportation elements are already well established and widely practiced with optimised costs. The remaining challenge is to demonstrate that an ammonia cracking process can be operated effectively and at sufficiently low cost for profitable business models to be established.

5.2.1. Stage 1 – Demonstration and market entry (transport)

The consortium will develop and test two complementary ammonia cracking technologies for pure hydrogen generation.

1. A small scale two stage system based on an optimized cracker with innovative catalyst material coupled with separate membrane purification unit
2. A larger-scale (200kg/day) advanced membrane reactor with an integrated purification membrane using commercial catalyst in a design with significantly reduced capital and operating cost compared to existing technology for pure hydrogen generation from ammonia.

The consortium will demonstrate the performance of the 5 kg/day and 200 kg/day H₂ crackers and in-parallel, will engage with potential suppliers of low/zero carbon ammonia, equipment fabricators and installers and end-users at a cost of £6.6m. This approach combines the technological capabilities of the consortium partners in a programme which will clarify and quantify the economic benefits of innovative catalysts and innovative reactor design. The learning obtained from the design, installation and operation of the test units will inform the detailed design of commercial products that will be subsequently deployed.

The use of hydrogen as a transport fuel has been identified as the first commercialisation opportunity as it is one of the highest added value applications and it offers significant potential to reduce both carbon emissions and airborne pollution. Despite this high added value, the costs of existing methods of production, storage and distribution are currently too high for a profitable investment model.

Costs are high because hydrogen for transport is either produced in small-scale, capital intensive, on-site electrolyzers or in large-scale facilities which are remote from end-users and suffer from high transportation costs. With any chemical production process, lowest costs will be achieved in large and efficient plants but the ability to benefit from the economies of scale can only be realised if the cost of distribution to end-users can be significantly reduced.

The feasibility study has determined that the cost of transportation of hydrogen, in the form of liquid ammonia is substantially lower than for the transportation of hydrogen as a compressed gas. For example, using 2018 operator costs published by the Freight Transport Association (38), the cost of transporting gaseous hydrogen in tube trailers at 190 bar has been calculated at £51.85/MWh per 100 miles (£1.73/kg H₂), whereas the equivalent cost using liquid ammonia is £6.55/MWh (£0.22/kg H₂).

The cost of production of hydrogen from a small scale (200kg/day H₂) ammonia cracker of the Engie advanced membrane reactor been estimated at £122.86/MWh (£4.10/kg H₂). Following the initial demonstrations, the Commercialisation Pathway is to site and operate ammonia crackers at 3rd party refuelling stations across the UK. Stations will be for public refuelling, or owned by large individual end-users such as rail, bus and HGV operators for their captive use. It is anticipated that initial market entry will be in the captive segment by alignment with specific projects for the decarbonisation of trains, bus fleets, materials handling etc.

The product for transport refuelling is expected to consist of a decentralised modular cracker capable of 200kg/day H₂ installed within a 40ft shipping container. Demand in excess of 200kg/day will be met by the installation of multiple modules.

The supply of H₂ in this first stage will necessarily be from existing sources or sources planned to be operational within 2-3 years. The carbon intensity of the H₂ will depend on a combination of availability (at acceptable cost) and end-user preference at this stage. A pragmatic approach will be taken in which it is recognized that even carbon intensive hydrogen can play a short-term role in establishing the market for hydrogen fuelled vehicles, thereby improving the case for subsequent investment in low/zero-carbon hydrogen production.

A sub-sector of the fuelling market is expected to develop which involves the use of hydrogen fuel cells to generate electricity for recharging battery electric vehicles at locations without an existing or adequate electricity supply to meet demand for recharging. This concept is being developed by Siemens and others. In this case, one or more 200kg/day ammonia crackers would be coupled with a hydrogen fuel cell.

As the transport application develops it is planned that a second product will be introduced, potentially a scaled up or combined units capable of producing 5tes H₂/day (2023). This will be located to serve several nearby H₂ fuelling stations with hydrogen transported a short distance by truck from the cracker to the refuelling stations. This option will be implemented where the cost savings achieved by larger scale cracking exceed the cost of short distance transportation of hydrogen. Ultimately, this will be the product appropriate for a single large-scale captive fuelling station or a public fuelling station providing 1,000 refuelling events per day when H₂ is widely adopted as a transport fuel (2035).

5.2.2. Stage 2 – Penetration into energy storage

As the UK capacity for renewable electricity generation increases, a cost-effective means of energy storage will be required to maximise the utilization of the generation assets and balance supply with demand. H₂ is a candidate for this application and its large-scale storage in salt caverns is a promising prospect. An alternative, or complimentary means of H₂ storage is in the form of liquid ammonia using above ground tank farms and this forms the basis of the second stage of the Commercialisation Pathway. The technology for such tanks is well established, of modest cost and already widely used for both ammonia and LPG which have similar physical properties and can be maintained as a liquid at modest pressure, without additional cooling.

The true practicality and cost-effectiveness of liquid ammonia as a means of storing hydrogen arises from its significantly higher volumetric density. For comparison, 1te of H₂ occupies 69m³ at 200bar whereas, 1te of H₂ in the form of liquid ammonia occupies 8m³, although with efficiency losses in conversion, the true comparison is 16m³ for ammonia. The pressure at which hydrogen can be stored in underground caverns depends on the geology. 200bar represents the top end of potential storage pressure and a working figure of 70bar is more realistic. At this pressure, 1te H₂ occupies 184m³

A state of the art, world scale ammonia plant would typically produce 1 million tonnes per annum of ammonia, equivalent to 176,500tpea of H₂. In gross (HHV) energy terms, this represents 6.8TWh per annum. For optimum economics, an ammonia plant needs to operate continuously at full capacity. This is at odds with the intermittent nature of renewable electricity generation and consumer demand. A practical deployment would therefore need to either be coupled to significant hydrogen and/or energy storage or be integrated with hydrogen produced by SMR or ideally SMR + CCUS. In the first case, it is anticipated that the amount and cost of storage would negate the benefits of ammonia production and cracking. In the latter case, there is intrinsic value in the ability to store H₂ produced by SMR + CCS for conversion to power when demand and prices are high. The integration of both renewable H₂ and SMR + CCUS H₂ into a new, or existing ammonia production facility has the potential to improve the economics of both means of H₂ generation. It should be noted that, as well as producing ammonia for energy storage, a facility could also produce ammonia for sale as fertilizer and the decision to sell to the power or fertilizer markets would be based on the prevailing prices.

Storage tanks for LPG which have a similar design and duty to tanks for ammonia have been constructed up to 130,000m³ capacity (39). A single tank of this size would hold approximately 0.5TWh of liquid ammonia. The storage and use of ammonia for grid balancing will be explored working with appropriate partners in the chemical industry. Small deployments will be trialled from 2025 with full-scale implementation by 2035 at 2.5TWh storage scale.

5.2.3. Stage 3 – Mass use for decarbonised heat

In locations with continuous, long and predictable sunshine, combined with hydrogen/energy storage and/or wind power (if the wind resources are good) to cover periods of darkness, hydrogen and ammonia can potentially be produced with very good economics. Where solar or wind resources are optimal, the cost of electricity is anticipated to be below £24/MWh MWh. Recent bids for solar plant projects in the Middle East have already indicated prices as low as \$23.4/MWh (£19/MWh) (25). At £24/MWh, high load factors and a large plant, the cost of hydrogen would be less than £49/MWh (£1.60/kg). The International Energy Agency has also estimated that the cost of hydrogen from SMR + CCUS could be as low as £37/MWh (£1.20/kg) in the Middle East and USA (24).

Liquid ammonia has physical properties similar to LPG and ships capable of transporting LPG can generally be used for ammonia. The Feasibility Study has determined that the total cost of shipping ammonia from Qatar through the Suez Canal to the UK (6,266 nautical miles) in a typical dual purpose LPG/NH₃ very large gas carrier containing 60,000tes would be £5.37/MWh (£0.18/kg H₂) including canal fees, port costs, insurance and return of the empty vessel. All-in costs for an end-to-end process with hydrogen produced in the Middle East and delivered to the UK using ammonia as a hydrogen carrier could amount to approximately £100/MWh (HHV, £3.35/kg).

BEIS projections of the price of UK wholesale electricity suggest a long-term (2035) price of around £65/MWh (\$80/MWh) (26). Assuming this represents the opportunity cost below which a renewables generator will produce hydrogen, rather than sell electricity, a 2019 IEA analysis (24) indicates that this will give a hydrogen production cost by electrolysis of £120/MWh to £150/MWh (£3.23 to £4.03/kg), depending on load factor and assuming a capital cost of £366/kWhe (\$450/kWhe).

These economics provide a commercial basis for the large-scale importation of renewable hydrogen in the form of liquid ammonia which, after cracking, could be used for a full range of applications including heat via injection into the national gas grid.

In 2018, the UK imported 5.8 million tonnes of liquified natural gas (LNG) and liquified petroleum gases (LPG) equivalent to 88TWh from locations such as the Middle East, Russia and the USA (40). Liquid ammonia has the potential to substitute these imports as a low/zero carbon alternative. Substitution of all the 2018 imports of LNG and LPG would require 14.1 million tonnes of ammonia or 235 shipments per year in typical LPG vessels of 60,000 tonnes capacity. CO₂ savings of 16.5 million tonnes would be achieved in this scenario, assuming ships using zero-carbon ammonia as fuel or 15.5 million tonnes if conventional fuel oil is used for transit distances of 6000 nautical miles. This is approximately 10% of the total CO₂ emitted from natural gas consumption in the UK in 2017 and has an economic value of £1.5 billion at a carbon price of £90.40/te CO₂e.

In this stage of the Commercial Pathway, the cracking technology developed in this project will be very widely employed and the cracking plants are expected to be operated by the consortium and a large number of licensees. The intention is to have agreements with overseas suppliers of low/zero carbon ammonia in place by 2025 with initial shipments from 2030, reaching 80+TWh by 2050.

The realization of the above scenario will require coordinated investment in the production of low/zero-carbon hydrogen in locations with favourable renewables generation and integration with ammonia production facilities. Substantial export opportunities exist for this technology as the proposed approach is expected to be adopted by several other countries with limited access to renewables.

The staged roll out of the cracker technology will resolve a key issue with hydrogen as a low/zero-carbon energy carrier, namely, the cost and practical difficulties of transporting it between low cost sources of production and end-users. The reduction of cost will improve the attractiveness of investment in hydrogen technology and will accelerate its widespread introduction.

⁷ Mohammed bin Rashid Al Maktoum Solar Park III = \$29.9/MWh, Mohammed bin Rashid Al Maktoum Solar Park IVb = \$24.0/MWh, Noor Abu Dhabi = \$29.4/MWh, Sakaka = \$23.4/MWh

REFERENCES

1. A mini-review on ammonia decomposition catalysts for on-site generation of hydrogen for fuel cell applications. C.T.Au, S.F.Yin B.Q.Xu X.P.Zhou. 1, s.l. : Applied Catalysis A: General,, 2004, Vol. 277. ISSN 0926-860X.
2. Ammonia as a possible element in an energy infrastructure: catalysts for ammonia decomposition. Schüth, F., Palkovits, R., Schlögl, R., Su, D. S. 4, s.l. : The Royal Society of Chemistry, 2012, Vol. 5.
3. Low-temperature ammonia decomposition catalysts for hydrogen generation. Shreya Mukherjee, Surya V. Devaguptapu, Anna Sviripa, Carl R.F. Lund, Gang Wu. s.l. : Applied Catalysis B: Environmental, 2018, Vol. 226. ISSN 0926-3373.
4. Kordesch, V. Hacker and K. Ammonia crackers. Handbook of Fuel Cells – Fundamentals, Technology and Applications. Chichester : John Wiley & Sons, 2003, Vol. 3.
5. William Owen JONES, William I. F. DAVID. A method for producing hydrogen from ammonia. WO2013057473A1 US JP EP CN WO, 21 10 2011.
6. Martin Owen Jones, William Ian Fraser David, Joshua William MAKEPEACE. A method of producing hydrogen. WO2015044691A1 GB WO EP JP CN US, 30 09 2013.
7. Hydrogen Production from Ammonia Using Sodium Amide. David, William I. F., Makepeace, Joshua W., Callear, Samantha K., Hunter, Hazel M. A., Taylor, James D., Wood, Thomas J., Jones, Martin O. 38, s.l. : Journal of the American Chemical Society, 2014, Vol. 136. 0002-7863.
8. Makepeace, Wood, Hunter, Jones & David. Ammonia decomposition catalysis using non-stoichiometric lithium imide. Chemical Science. 2015, 7.
9. Isotopic studies of the ammonia decomposition reaction using lithium imide catalyst. Wood, Thomas J. and Makepeace, Joshua W. and David, William I. F. 6, s.l. : The Royal Society of Chemistry, 2017, Vol. 19. doi: 10.1039/C6CP07734J.
10. Magnesia--Carbon Nanotubes (MgO--CNTs) Nanocomposite: Novel Support of Ru Catalyst for the Generation of CO_x-Free Hydrogen from Ammonia. Yin, S.F. and XU,B.Q. and Wang, S.J. and Ng,C.F. and Au, C.T. 3, s.l. : Catalysis Letters, 2004, Vol. 96.
11. Makepeace, J. W. Light metal amides for hydrogen storage and ammonia decomposition. s.l. : University of Oxford., 2014.
12. Demonstrating hydrogen production from ammonia using lithium imide - Powering a small proton exchange membrane fuel cell. Hunter, Makepeace, Wood, Mylius, Kibble, Nutter, Jones & David. 2016, Power Sources, pp. 138-147.
13. American Iron and Steel Institute. High-Temperature Characteristics of Stainless Steel. s.l. : Nickel Development Institute.
14. Modelling heat transfer during flow through a random packed bed of spheres. Per E. C. Burström, Vilnis Frishfelds, Anna-Lena Ljung, T. Staffan Lundström, B. Daniel Marjavaara. s.l. : Heat and Mass Transfer, April 2018, Vol. 54.
15. Committee on Climate Change. Net Zero: The UK's contribution to stopping global warming. s.l. : Committee on Climate Change, 2019.

16. The Linde Group. Linde raises the bar for hydrogen transport efficiency. Munich : s.n., 2013.
17. Hydrogen Europe. Hydrogen, enabling a zeroemission Europe, Technology Roadmaps. 2018.
18. DeliverHy (FCHJU funded programme). Impact of high capacity CGH2 trailers. 2013.
19. Lawrence Livermore National Laboratory. DOE Hydrogen and Fuel Cells Annual Merit Review - Liquid Hydrogen Infrastructure Analysis. Washington DC : s.n., 2017.
20. Gardiner, Monterey. Energy requirements for hydrogen gas compression and liquefaction as related to vehicle storage needs. s.l. : United States Department of Energy, 2006.
21. US Energy Information Administration. Today in Energy. US Energy Information Administration. [Online] 14 February 2013. <https://www.eia.gov/todayinenergy/detail.php?id=9991>.
22. Costs of storing and transporting hydrogen. Amos, W.A. s.l. : National Renewable Energy Laboratory (NREL/TP-570-25106, 1998.
23. Benner, J., van Lieshout, M., Croezen, H. Identifying Breakthrough Technologies for the Production of Basic Chemicals. A Long Term View on the Production of Ammonia, Olefins and Aromatics in the European Union. s.l. : University of Delft, 2012.
24. International Energy Agency. The Future of Hydrogen. 2019.
25. IRENA. Renewable Energy Market Analysis:GCC 2019. Abu Dhabi : IRENA, 2019.
26. BEIS. Updated energy and emissions projections: 2018 - Annex M Price growth assumptions. s.l. : HM Government, 2019e.
27. Loucheim, Justin. Fertilizer History: The Haber-Bosch Process. s.l. : The Fertiliser Institute, 2014.
28. Potashcorp. Overview of Potashcorp and its industry. Potashcorp. [Online] 8th January 2013. [Cited: 4th September 2019.] http://potashcorp.s3.amazonaws.com/PotashCorp_Industry_Overview.pdf.
29. Centre for European policy Studies. A study on the composition and drivers of energy prices and costs in energy intensive industries: The case of the chemical industry - Ammonia. s.l. : Centre for European Policy Studies, 2014.
30. CREG. A European comparison of electricity and gas prices for large industrial consumers. s.l. : PWC, 2019.
31. Yara. Yara Fertilizer Industry Handbook. s.l. : yara, 2018.
32. philibert, Cedric. Producing ammonia and fertilizers: New opportunities from renewables. s.l. : IEA, 2017.
33. BEIS. The Clean Growth Strategy - Leading the way to a low carbon future. s.l. : HM Government, 2017.
34. IRENA. Global Energy Transformation: A roadmap to 2050 (2019 edition). Abu Dhabi : International Renewable Energy Agency, 2019.
35. BEIS. Digest of United Kingdom Energy Statistics 2018 - Value of imports and exports of fuels (DUKES G.7). s.l. : HM Government, 2019a.
36. Hydrogen Council. Hydrogen - Scaling up. 2017.
37. IEA. Hydrogen - Tracking Clean Energy Progress. International Energy Agency. [Online] 31 July 2019. <https://www.iea.org/tcep/energyintegration/hydrogen/>.

38. Freight Transport Association. Manager's Guide to Distribution Costs. s.l. : Freight Transport Association, 2018.
39. Osaka Gas Company. Project to construct one of the world's largest LNG storage tanks. Osaka Gas. [Online] 7th October 2019. https://www.osakagas.co.jp/en/company/enterprise_future/article2/.
40. BEIS. Energy Trends: UK Gas. Gov.co.UK. [Online] 6 August 2019f. <https://www.gov.uk/government/statistics/gas-section-4-energy-trends>.
41. Global Carbon Project. Carbon budget and trends 2018. 2018.
42. Ronneau, Adapted from C. Energie, pollution de l'air et developpement durable. Louvain-la-Neuve : Presses Universitaires de Louvain, 2004.
43. Kobayashi, H. 2019, Proceedings of the Combustion Institute, Vol. 37, pp. 109-133.
44. Appl, M. Ammonia: Principles and Industrial Practice. s.l. : Weinheim, 1999.
45. Large Scale Ammonia Storage and Handling. Webb, D. s.l. : IRC Research & Technology Forum, 2001.
46. Wind-powered ammonia fuel production for remote islands: a case study. Morgan, E, Manwell, J., McGowan,. 2014, Renewable Energy, Vol. 72, pp. 51-61.
47. Brown, Trevor. Renewable ammonia demonstration plant announced in South Australia. Ammonia Industry. 02 01 2018.
48. Argus Media Group. LPG. Argus Freight. 30th January 2019, 19-21, p. 8.
49. Hydrogen Europe. Hydrogen Applications. Hydrogen Europe. [Online] 30th July 2019. [Cited: 30th July 2019.] <https://hydrogeneurope.eu/hydrogen-applications>.
50. Engie. DSR White Paper - Demand-side response services. Engie. [Online] 30th July 2019. <https://www.engie.co.uk/wp-content/uploads/2018/03/dsr-whitepaper.pdf>.
51. H21 North of England. H21 NoE Report/2018. 2018.
52. Ferticon Agribusiness Intelligence. Magellan Ammonia Pipeline Closure: An Impact Assessment. s.l. : Ferticon, 2019.
53. National Statistics. Energy Trends: UK Gas - Natural Gas Imports (ET4.4). s.l. : HM Government, 2019.
54. BEIS. UK Energy Statistics, 2018 & Q4 2018. s.l. : HM Government, 2019c.
55. —. Digest of United Kingdom Energy Statistics 2018 - Imports and exports of fuels (DUKES G.1). s.l. : HM Government, 2019b.
56. —. Digest of UK Energy Statistics 2018 - G.3 Imports and exports of crude oil and petroleum products. s.l. : HM Government, 2019d.
57. MarketsandMarkets. Global Hydrogen Generation Market by Merchant & Captive Type, Distributed and Centralised Generation, Applications & Technology- Trends & Forecasts 2011-2016. s.l. : MarketsandMarkets, 2017.
58. Liquefied Gas Carrier. Liquefied Gas Carrier - Safety & operational matters. Liquefied Gas Carrier. [Online] 2

- August 2019. <http://www.liquefiedgascarrier.com/Fully-Refrigerated-Ships.html>.
59. Advisian. South Australian Green Hydrogen Study. Melbourne : Government of South Australia, 2017.
60. Grubb, Michael and Drummond, Paul. UK industrial electricity prices: competitiveness in a low carbon world. s.l. : Aldersgate Group, 2018.
61. Searates. Searates Distances and time calculator. Searates. [Online] 7 August 2019. <https://www.searates.com/services/distances-time/>.
62. Drewry Maritime Research. Drewry Maritime Research - LPG Forecaster. Drewry maritime Research. [Online] 5 July 2019. <https://www.drewry.co.uk>.
63. The Oxford Institute for Energy Studies. The LNG Shipping Forecast: costs rebounding, outlook uncertain. Oxford : University of Oxford, 2018.
64. BP Shipping. GEM Class. BP Shipping. [Online] 7 August 2019. <https://www.bp.com/en/global/bp-shipping/our-fleet/gas/gem-class.html>.
65. Wilhelmsen. Suez Toll Calculator. Wilhelmsen. [Online] 7 August 2019. <https://www.wilhelmsen.com/tollcalculators/suez-toll-calculator/>.
66. Myship. Flanders Tenacity. Myship.com. [Online] 7 August 2019. <http://myship.com/imo/9113379/FLANDERS-TENACITY>.
67. MAN Energy Solutions. MAN B&W ME-LGIP dual fuel engines. s.l. : MAN Energy Solutions, 2018.
68. Sampson, Joanna. French Minister unveils €100m hydrogen plan. Gasworld. [Online] 1 June 2018. <https://www.gasworld.com/french-minister-unveils-100m-hydrogen-plan/2014840.article>.
69. METI. The Strategic Road Map for Hydrogen and Fuel Cells: Industry-academia-government action plan to realize "Hydrogen Society". s.l. : Ministry of Economy Trade and Industry, Japan, 2019.
70. Country Highlights: China - Technology Roadmap of Fuel Cell Vehicle (FCV) in China. Zheng, Yali. Linz, Austria : weSRCH, 2019. 57th ExCo Meeting.
71. Rijksdienst voor Ondernemend Nederland. [Online] 2019. [Cited: 14 August 2019.] <https://www.rvo.nl/sites/default/files/2019/03/Overview-of-Hydrogen-and-Fuel-Cell-Developments-in-China.pdf>.
72. Carr, Jackson. Germany Fuel Cell Industry Developments. FCHEA Fuel Cell & Hydrogen Energy Association. [Online] 25 March 2019. <http://www.fchea.org/in-transition/2019/3/18/germany-fuel-cell-industry-developments>.
73. Deployment of Hydrogen and Fuel Cell Technology in Germany. Herbert, Thorsten. Malaga, Spain : National Organisation hydrogen and Fuel Cell Technology, 2018. EHEC.
74. H₂Mobility Belgium. National Implementation Plan - Hydrogen Refuelling Infrastructure Belgium. s.l. : WaterstofNet, 2015.
75. National Innovation Programme - Hydrogen and Fuel Cell Technology (NIP). Wegener, Jan. Berlin : s.n., 2018. 22nd Annual German Norwegian Energy Forum.
76. Sampson, Joanna. Ballard and Van Hool receive largest order ever for hydrogen buses in Europe. Gasworld. [Online] 1 March 2018. <https://www.gasworld.com/ballard-and-van-hool-receive-largest-order-ever-for-h2-buses/2014274.article>.

77. Choi, Darren and Lim, Dylan CH. Hydrogen: Powering South Korea's Future. s.l. : eastspring investments, 2019.
78. California Fuel cell Partnership. By the Numbers - FCEV Sales, FCEB & Hydrogen Station Data. California Fuel cell Partnership. [Online] 27 August 2019. https://cafcp.org/by_the_number.
79. Office of Governor Edmund G. Brown Jr. Governor Brown Takes Action to Increase Zero-Emission Vehicles, Fund New Climate Investments. CA.gov. [Online] 26 January 2018. <https://www.ca.gov/archive/gov39/2018/01/26/governor-brown-takes-action-to-increase-zero-emission-vehicles-fund-new-climate-investments/index.html>.
80. Faulkner, Tim. Hydrogen Filling Stations Opening in Northeast. ecoRI news. [Online] 24 October 2018. <https://www.ecori.org/transportation/2018/10/21/hyaxjnygtebfhgnab1kwjxiqims5zp>.
81. Nikola Motor. Nikola One. Nikola Motor. [Online] 27 August 2019.



ADDITIONAL REFERENCES

- [1] Z. Zhang, S. Liguori, T.F. Fuerst, J.D. Way, C.A. Wolden, Efficient Ammonia Decomposition in a Catalytic Membrane Reactor to Enable Hydrogen Storage and Utilization, *ACS Sustain. Chem. Eng.* 7 (2019) 5975–5985.
- [2] Y.S. Jo, J. Cha, C.H. Lee, H. Jeong, C.W. Yoon, S.W. Nam, J. Han, A viable membrane reactor option for sustainable hydrogen production from ammonia, *J. Power Sources.* 400 (2018) 518–526.
- [3] J. Melendez, E. Fernandez, F. Gallucci, M. van Sint Annaland, P.L. Arias, D.A. Pacheco Tanaka, Preparation and characterization of ceramic supported ultra-thin ($\sim 1 \mu\text{m}$) Pd-Ag membranes, *J. Memb. Sci.* 528 (2017) 12–23.
- [4] A. Arratibel, J.A. Medrano, J. Melendez, D.A. Pacheco Tanaka, M. van Sint Annaland, F. Gallucci, Attrition-resistant membranes for fluidized-bed membrane reactors: Double-skin membranes, *J. Memb. Sci.* 563 (2018) 419–426.
- [5] A. Arratibel, A. Pacheco Tanaka, I. Laso, M. van Sint Annaland, F. Gallucci, Development of Pd-based double-skinned membranes for hydrogen production in fluidized bed membrane reactors, *J. Memb. Sci.* 550 (2018) 536–544.

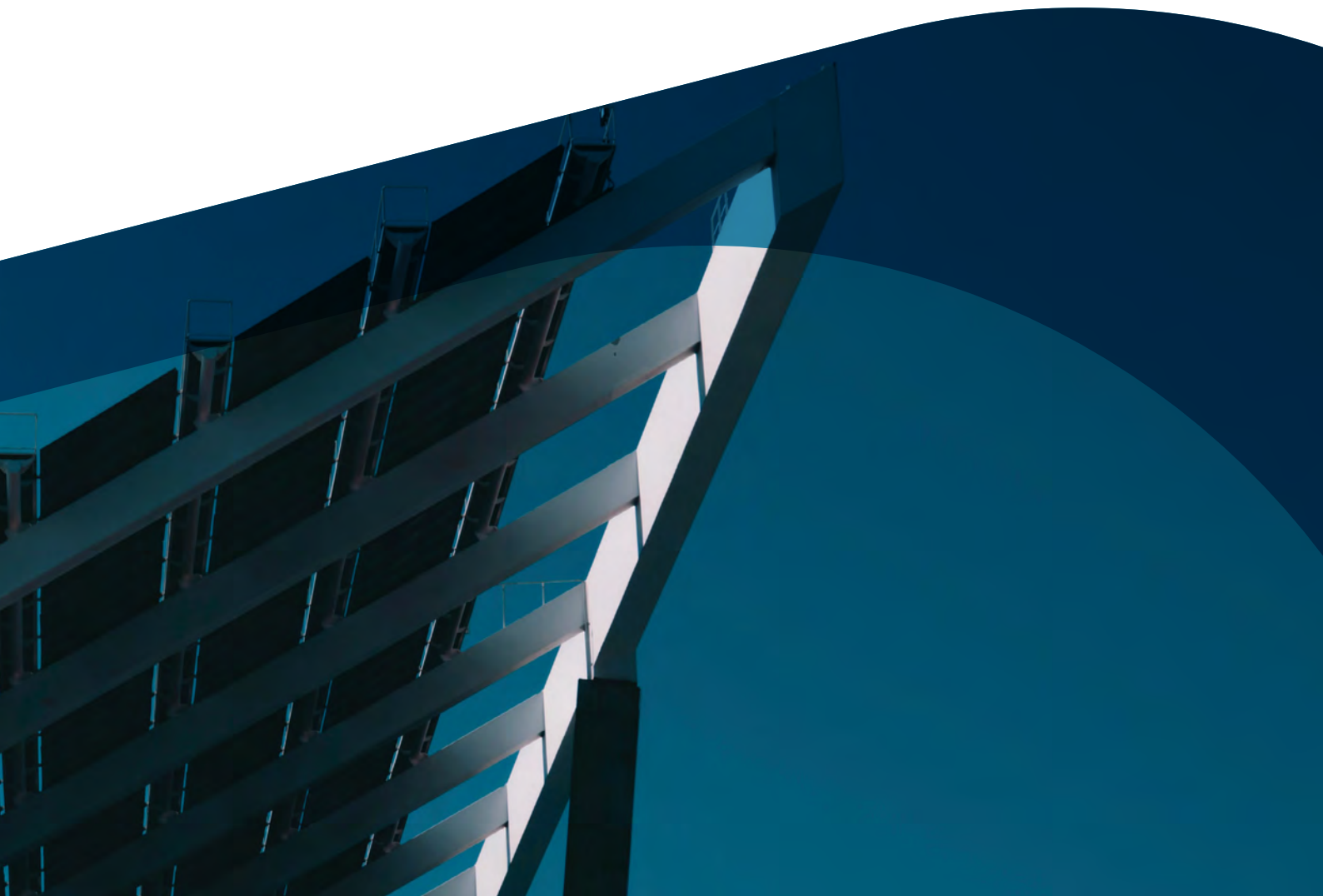



CONTACT US

0121 709 5587



[ecuity.com](https://www.ecuity.com)



Birmingham
B3 1BG

